

FLEXIBLE LIMITATIONS & RANGES OF MOVEMENT

STRAIGHT BASE OR CASING BENDING AGAINST THICKNESS

Applications bending against the smaller dimension usually the 1/2" - 1-1/2" thick (i.e. Base with measurements 5/8 x 4-1/2) will bend easily in the direction of the lesser dimension with no pre-curving necessary.

Minimum radius 10".

Product has a tendency to cup when bent too tight on wall.

Moulding will not bend around 3/4" or 1-1/2" bullnose corners.

STRAIGHT CROWN

NOT ADVISABLE. Customer should supply radius information to allow Resinart to confirm if straight will work.

MEASURING

Calculate approximate lengths needed using radius B in inches and round up to nearest foot. Use Radius A and Width A dimension for ordering actual part.

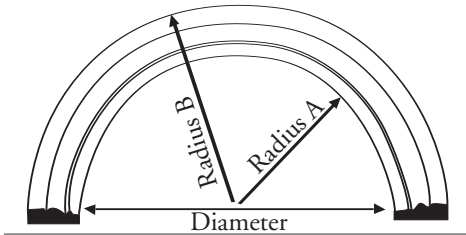

Radius B (x) 3.14 (÷) 12 = minimum length needed

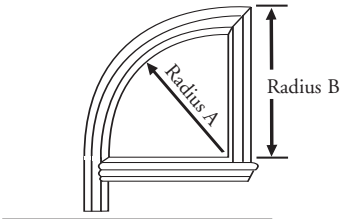

Radius B (x) 3.14 (÷) 2 (÷) 12 = minimum length needed

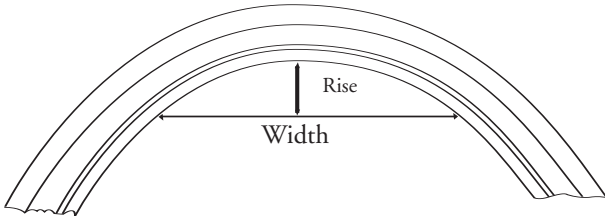

Rise (x) 2 (+) Width = minimum length needed

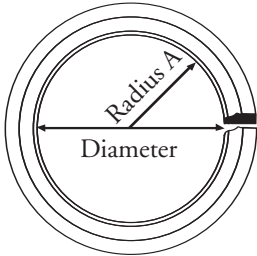

Diameter (x) 3.14 (÷) 12 = minimum length needed

CASING

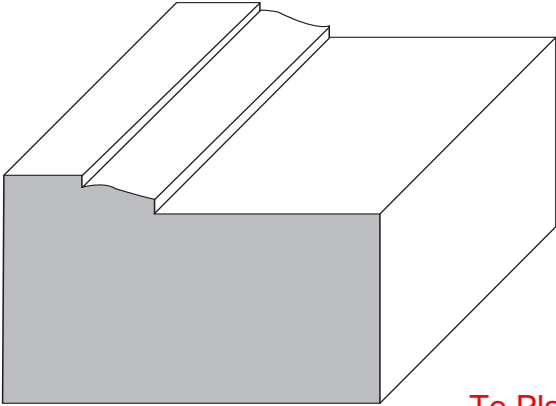

T-WM180
1 1/4 x 2

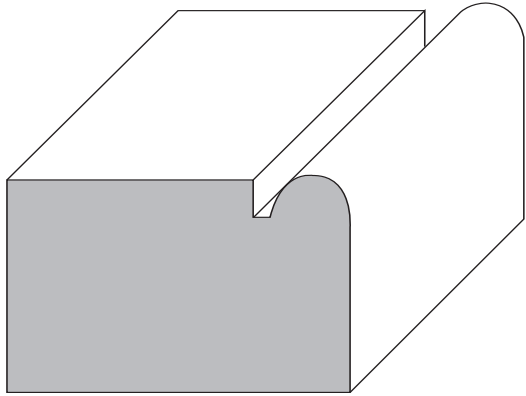

T-WM176
1 1/16 x 1 3/4

To Place an Order,
Call:
1-608-698-6645

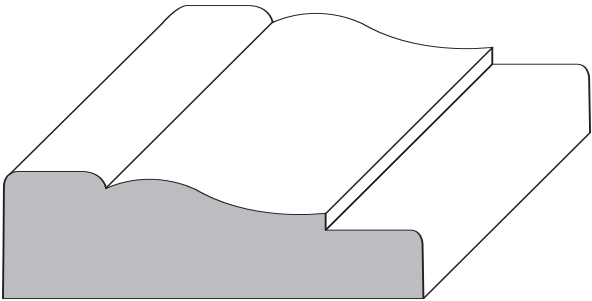

T-WM356
1 1/16 x 2 1/4

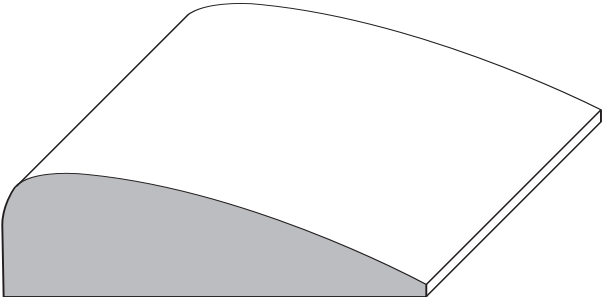

T-WM327
1 1/16 x 2 1/4

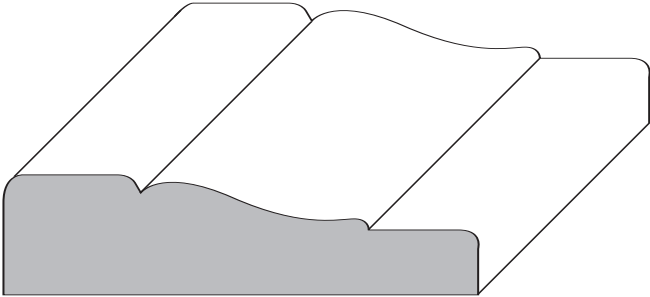

T-WM351
1 1/16 x 2 1/2

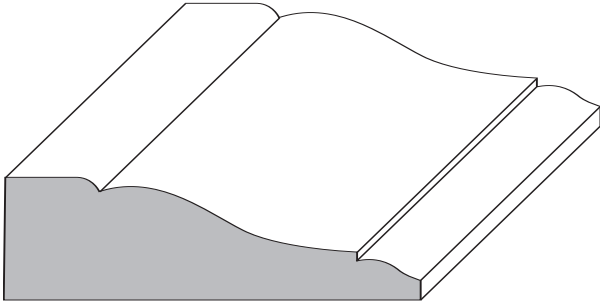

T-WM442
1 1/16 x 2 1/4

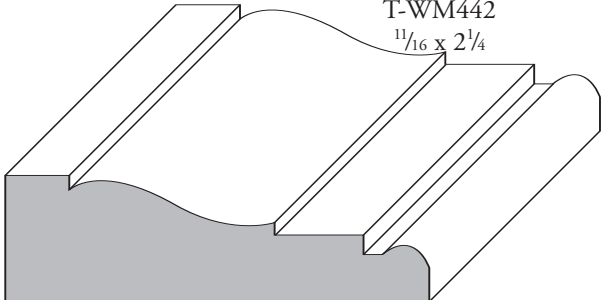

T-WM376
1 1/16 x 2 1/4

To Place an Order - Call:
1-608-698-6645

CASING

To Place an Order - Call:
1-608-698-6645

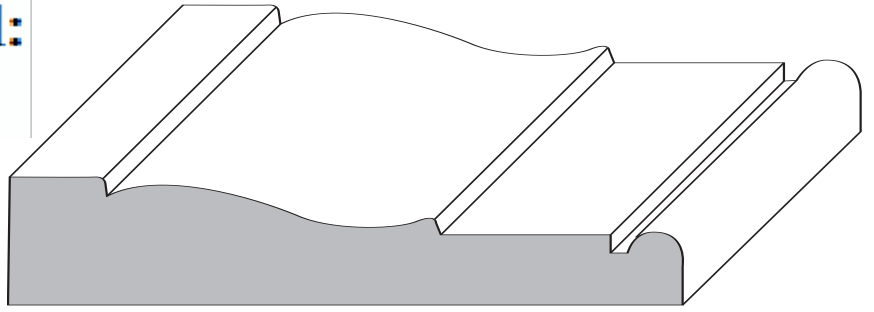

C-LW445
 $\frac{5}{8} \times 3\frac{1}{2}$

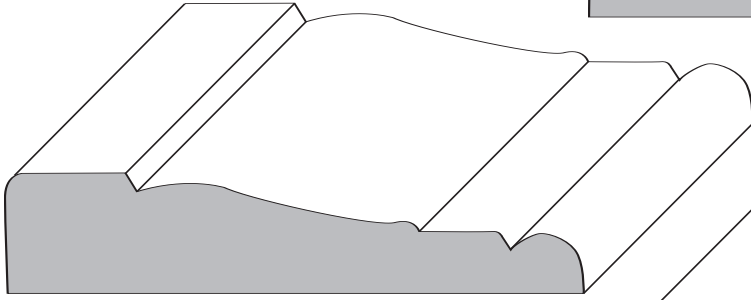

C-LW371
 $\frac{5}{8} \times 3$

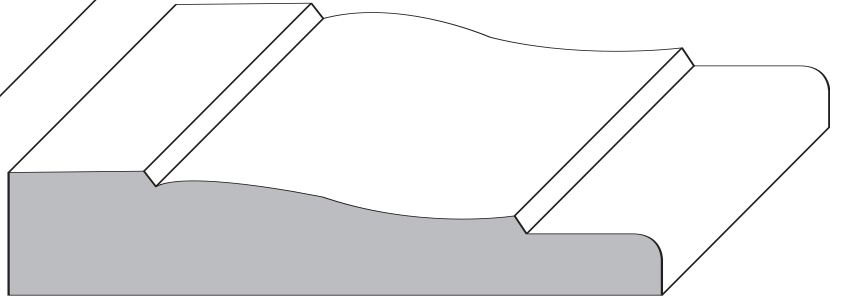

T-WM444
 $\frac{11}{16} \times 3\frac{1}{2}$

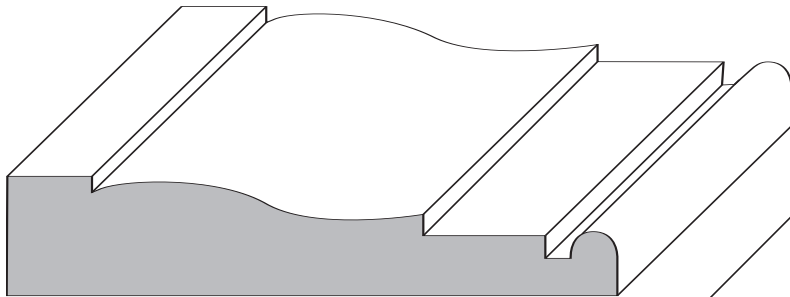

T-WM445
 $\frac{11}{16} \times 3\frac{1}{4}$

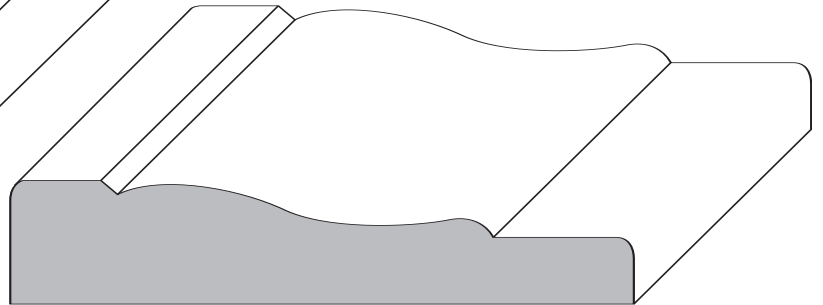

T-CT444
 $\frac{11}{16} \times 3\frac{1}{4}$

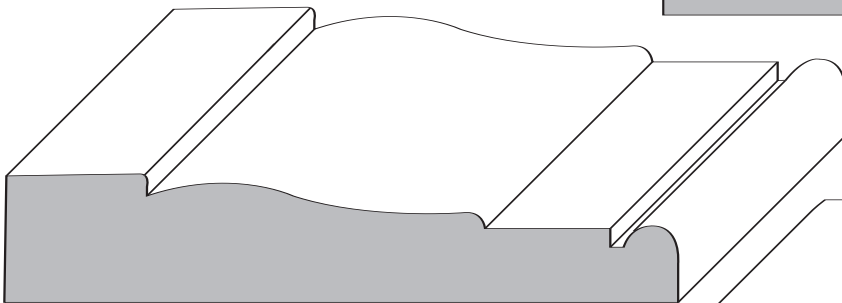

C-SDC99
 $\frac{5}{8} \times 3\frac{1}{2}$

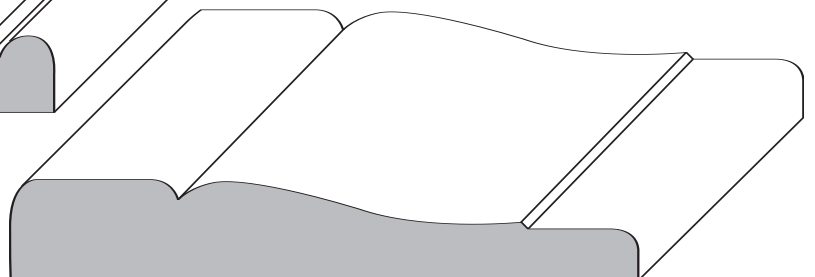

C-LW356
 $\frac{5}{8} \times 3\frac{1}{4}$

To Place an Order,
Call:
1-608-698-6645

CASING

**To Place an Order - Call:
1-608-698-6645**



T-WM430
 $\frac{9}{16} \times 4\frac{1}{4}$



T-WM432
 $\frac{9}{16} \times 3\frac{1}{2}$

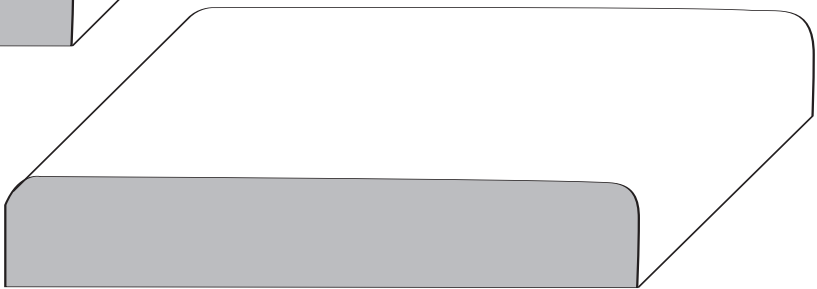

T-WM433
 $\frac{9}{16} \times 3\frac{3}{4}$

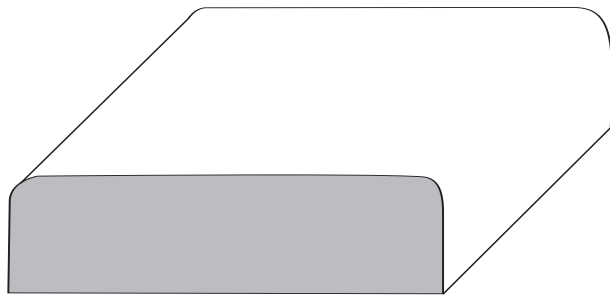

T-WM473
 $\frac{9}{16} \times 2\frac{1}{4}$

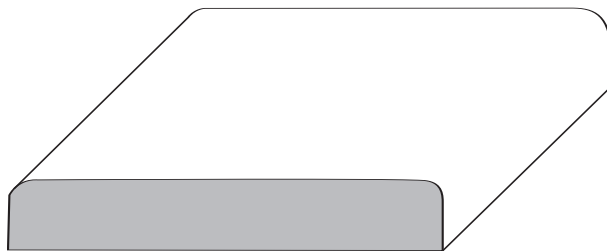

T-WM493
 $\frac{7}{16} \times 2\frac{1}{4}$

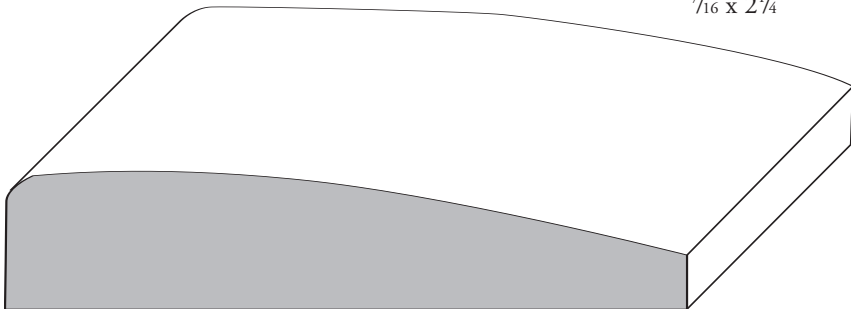

C-P2050
 $\frac{3}{4} \times 3\frac{1}{2}$

To Place an Order,
Call:
1-608-698-6645

CASING

To Place an Order - Call:
1-608-698-6645

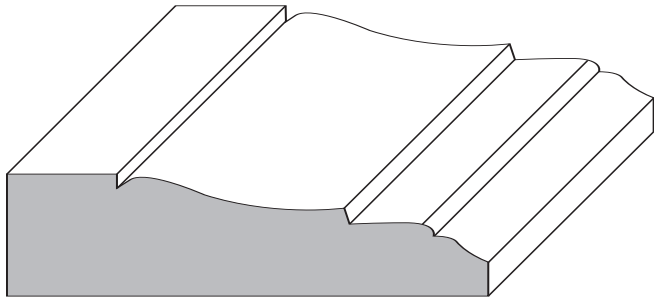

C-NJ149
 $\frac{11}{16} \times 2\frac{1}{2}$

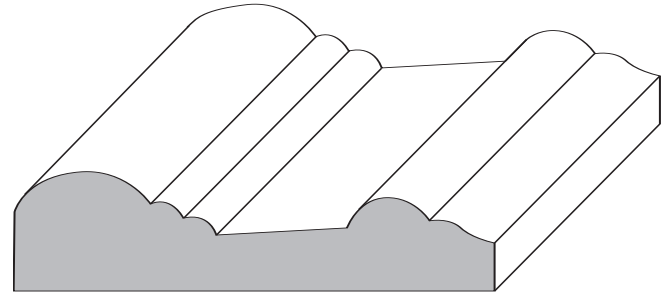

T-SL207
 $\frac{5}{8} \times 2\frac{1}{2}$

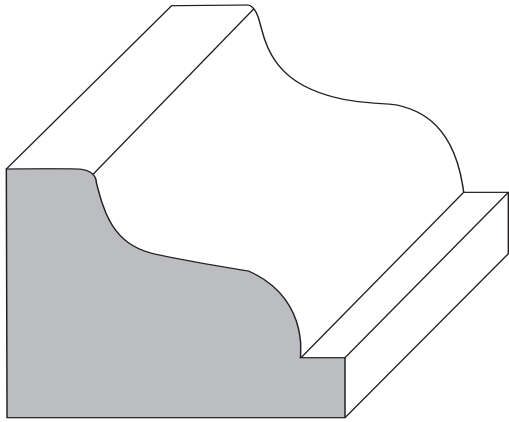

C-RRL03
 $1\frac{1}{4} \times 1\frac{3}{4}$

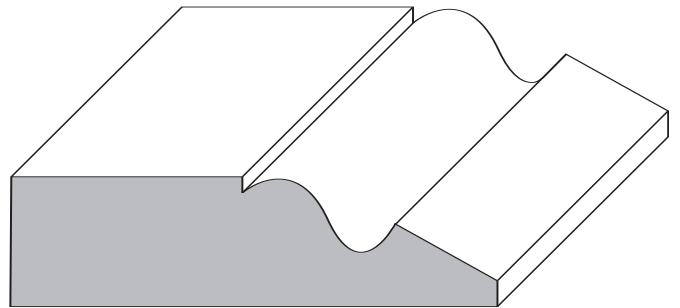

C-PO215
 $\frac{11}{16} \times 2\frac{1}{2}$

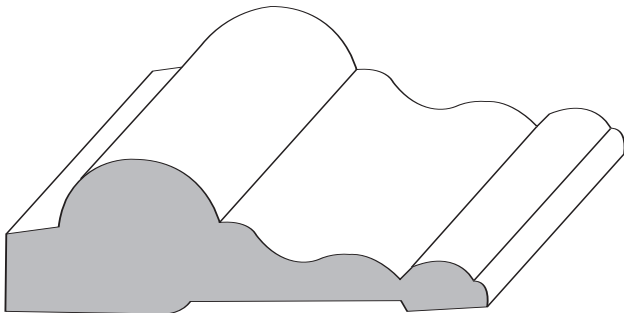

C-RB426
 $\frac{3}{4} \times 2\frac{1}{2}$

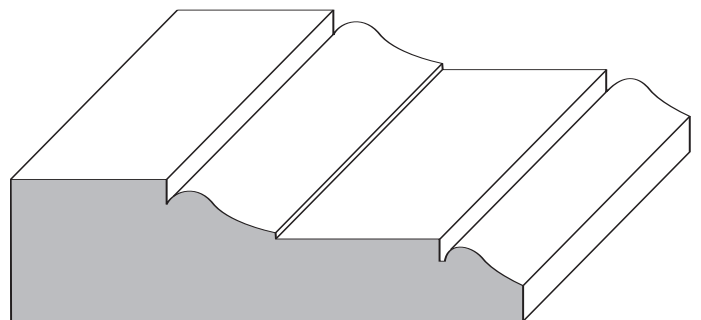

C-SS220
 $\frac{3}{4} \times 2\frac{5}{8}$

To Place an Order,
Call:
1-608-698-6645

CASING

To Place an Order,
Call:
1-608-698-6645

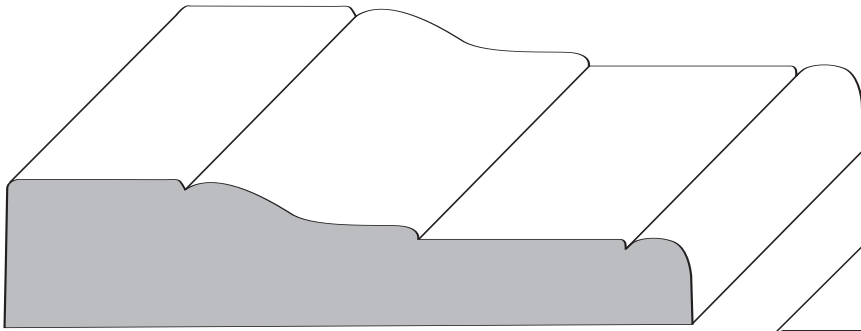

C-PM351
 $\frac{3}{4} \times 3\frac{1}{2}$

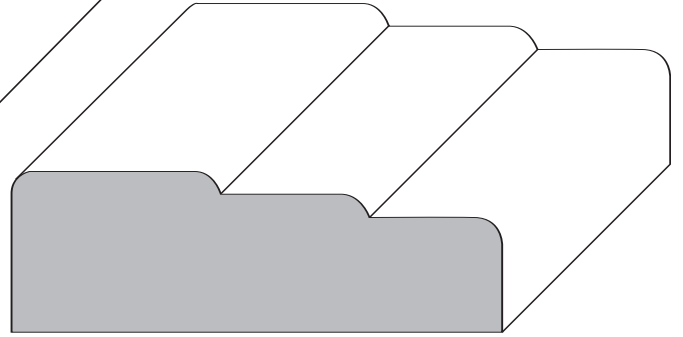

C-TH250
 $\frac{13}{16} \times 2\frac{1}{2}$

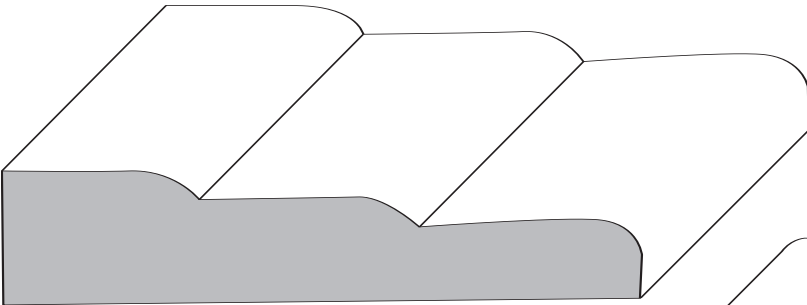

C-DC325
 $\frac{11}{16} \times 3\frac{1}{4}$

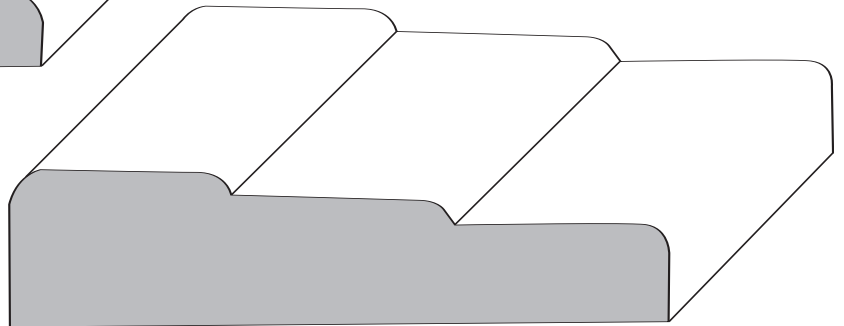

C-LM608
 $\frac{13}{16} \times 3\frac{1}{2}$

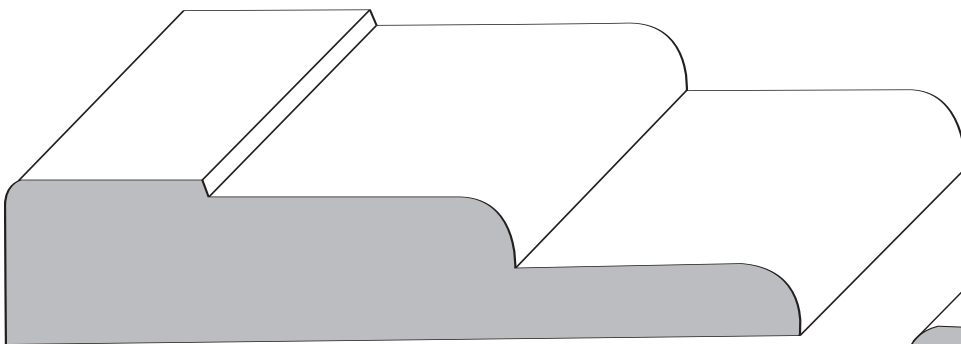

C-DE418
 $\frac{13}{16} \times 4\frac{1}{16}$

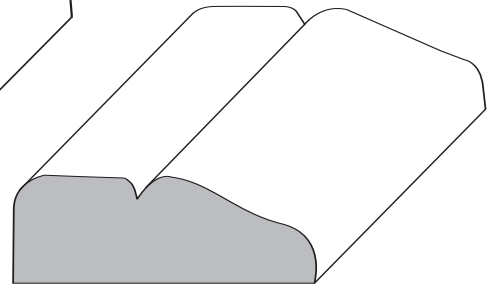

T-SL203
 $\frac{9}{16} \times 1\frac{5}{8}$

**To Place an Order - Call:
1-608-698-6645**

To Place an Order,
Call:
1-608-698-6645

CASING

**To Place an Order - Call:
1-608-698-6645**

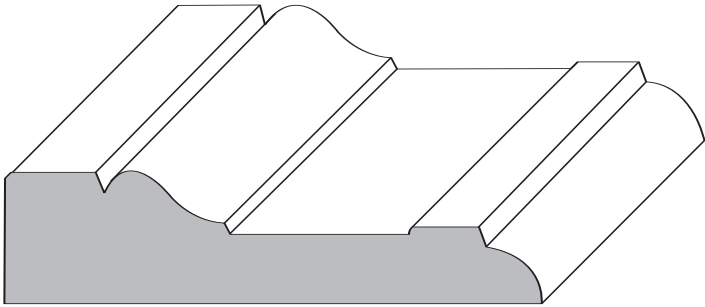

C-DY233
 $\frac{5}{8} \times 2\frac{3}{4}$

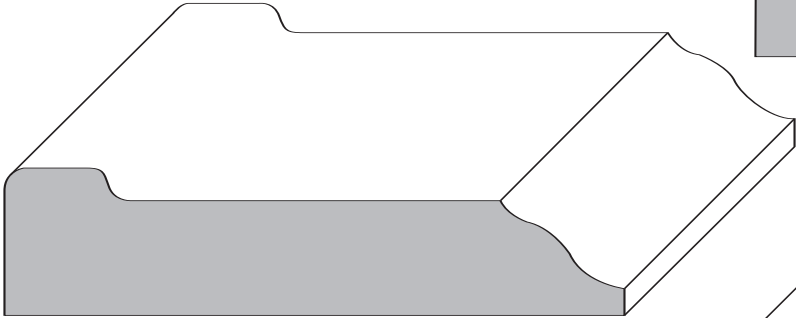

C-LD403
 $\frac{3}{4} \times 3\frac{1}{4}$

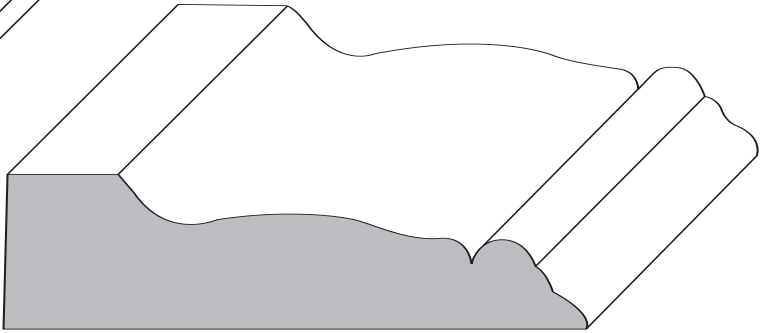

C-EM300
 $\frac{3}{4} \times 3$



C-NJ802
 $1\frac{1}{2} \times 2\frac{3}{4}$

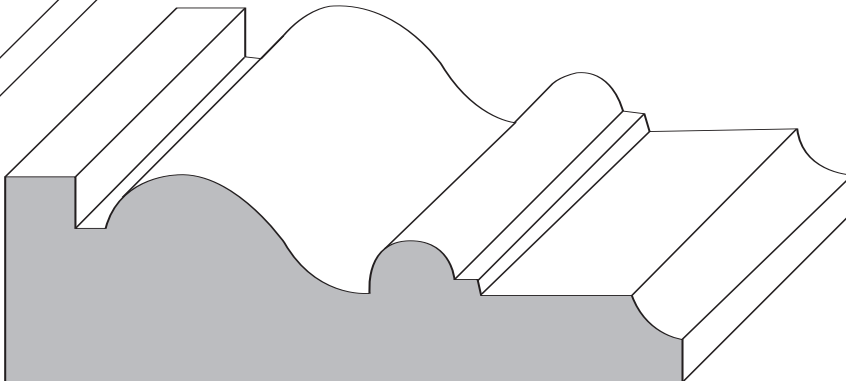

C-AS535
 $1\frac{1}{16} \times 3\frac{1}{2}$

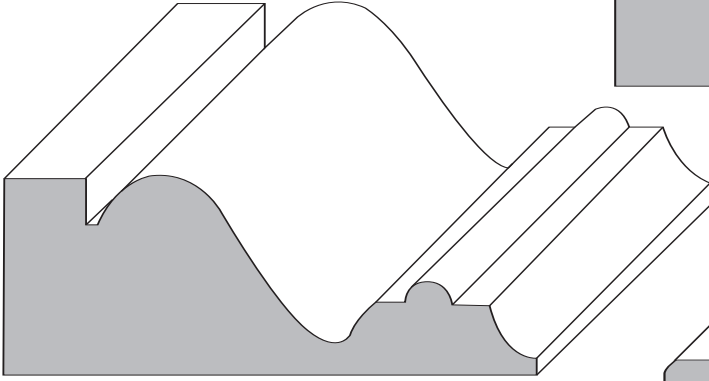

C-AM530
 $1\frac{1}{2} \times 2\frac{3}{4}$

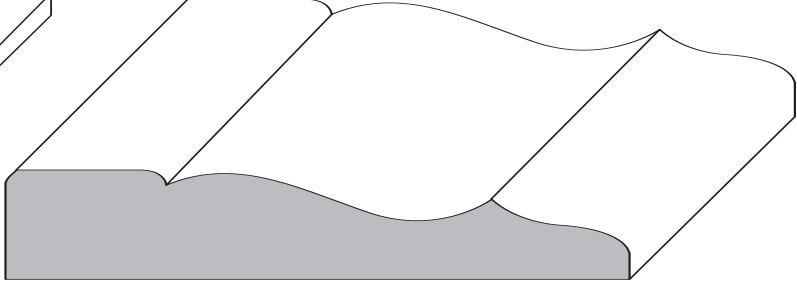

C-RLC22
 $\frac{9}{16} \times 3\frac{1}{4}$

**To Place an Order,
Call:
1-608-698-6645**

To Place an Order,
Call:
1-608-698-6645

CASING

To Place an Order,
Call:
1-608-698-6645

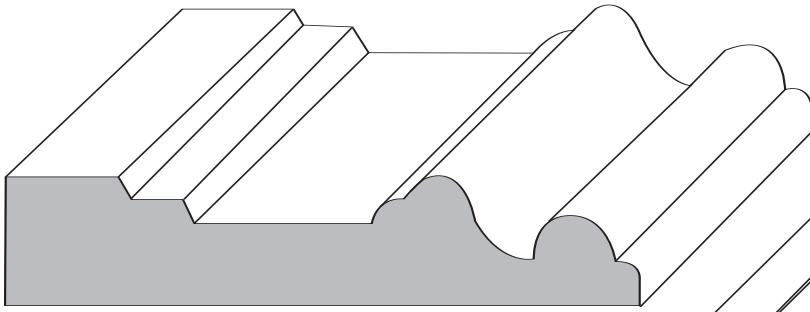

C-CHARL
 $\frac{5}{8} \times 3\frac{1}{4}$

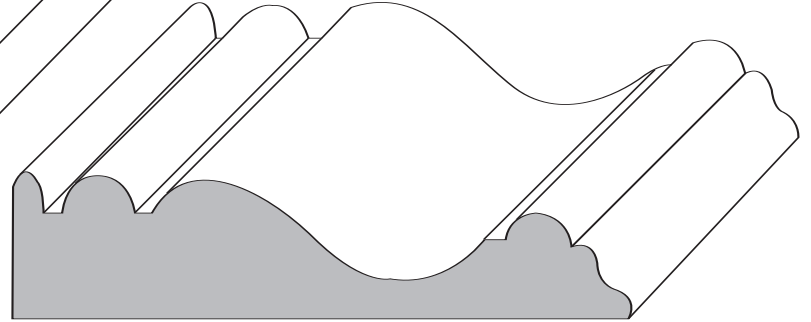

C-R265U
 $\frac{3}{4} \times 3\frac{1}{4}$

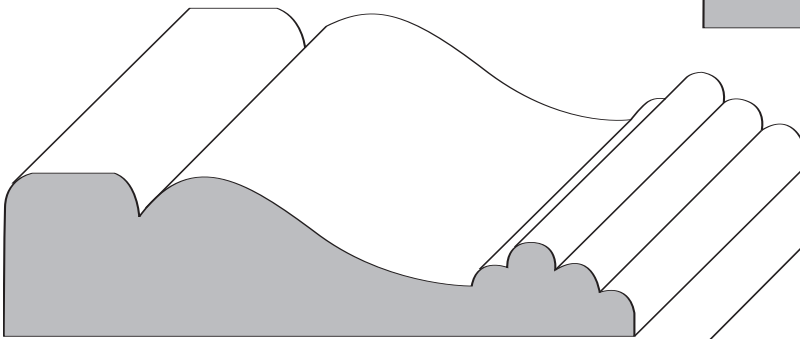

T-SL225
 $\frac{7}{8} \times 3\frac{1}{4}$

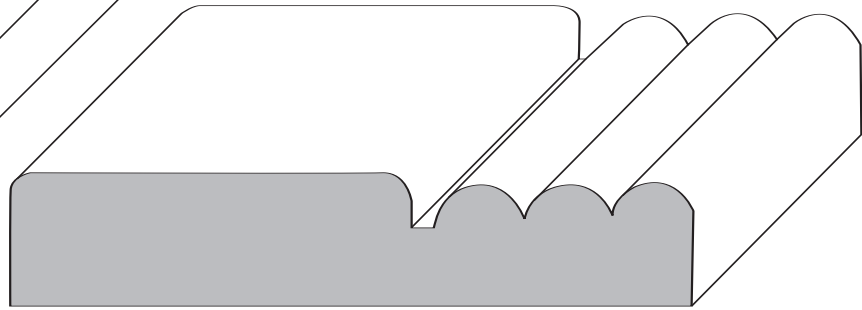

C-PM350
 $\frac{11}{16} \times 3\frac{1}{2}$

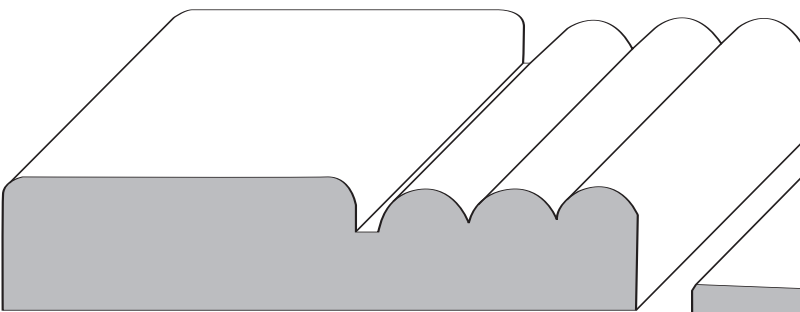

C-DC338
 $\frac{5}{8} \times 3\frac{3}{8}$

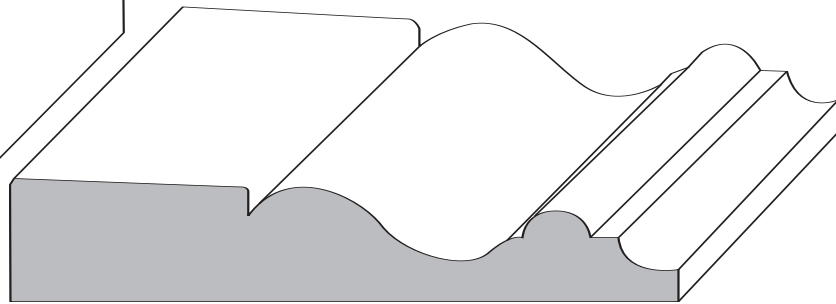

C-VI350
 $\frac{5}{8} \times 3\frac{1}{2}$

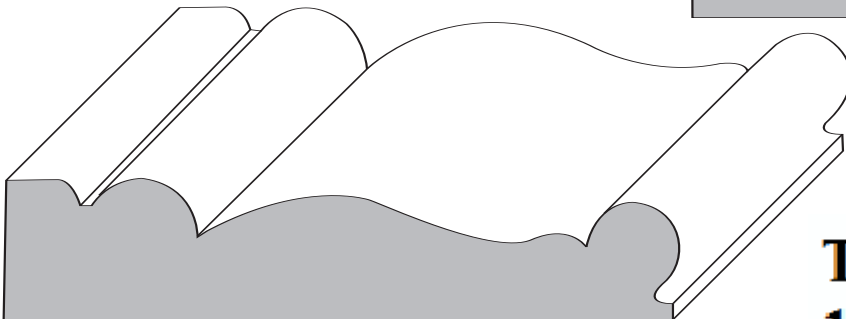

C-DS102
 $\frac{11}{16} \times 3\frac{1}{2}$

**To Place an Order - Call:
1-608-698-6645**

To Place an Order - Call:
1-608-698-6645

CASING

To Place an Order,
Call:
1-608-698-6645

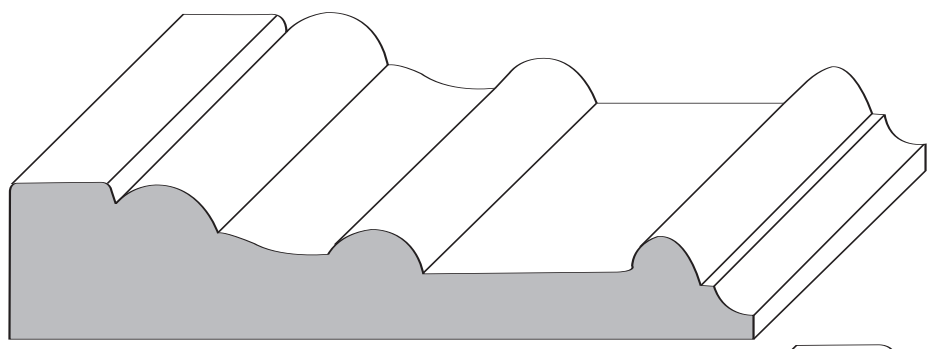

C-EM104
 $\frac{13}{16} \times 3\frac{3}{4}$

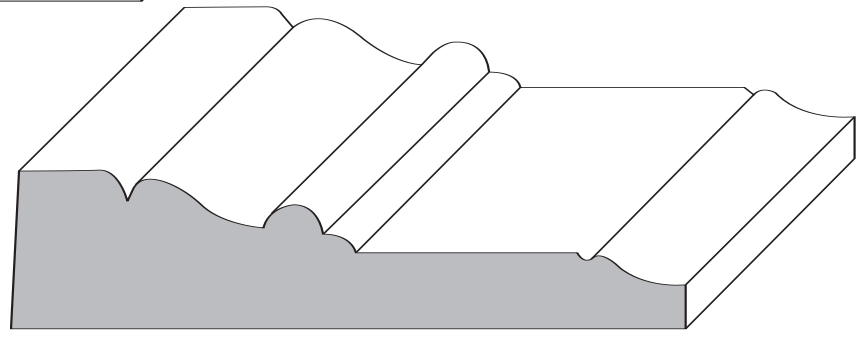

C-SMM3
 $\frac{13}{16} \times 3\frac{1}{2}$

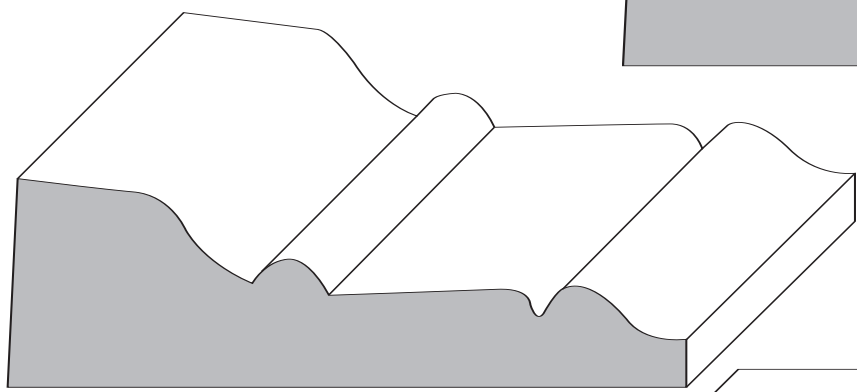

T-C1100
 $1 \times 3\frac{1}{2}$

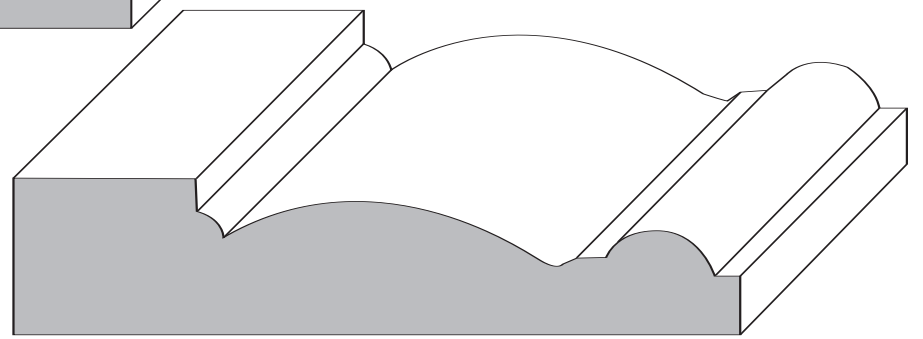

C-PM848
 $\frac{13}{16} \times 3\frac{3}{4}$

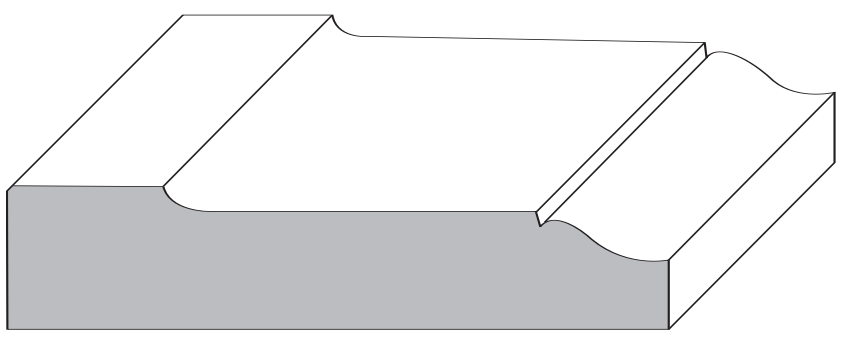

C-M21A
 $\frac{3}{4} \times 3\frac{3}{8}$

To Place an Order,
Call:
1-608-698-6645

CASING

**To Place an Order - Call:
1-608-698-6645**

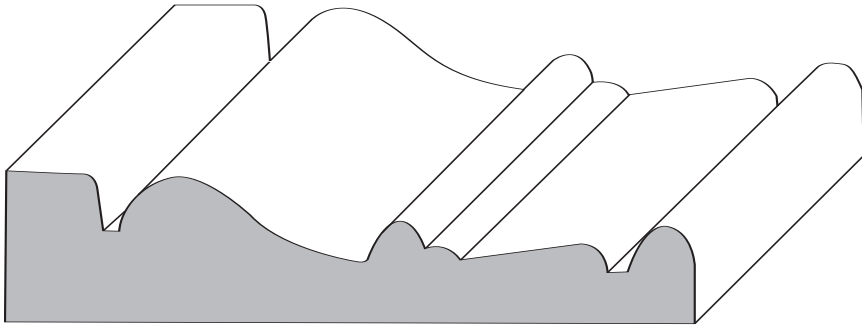

C-HLGRM
 $\frac{3}{4} \times 3\frac{5}{8}$

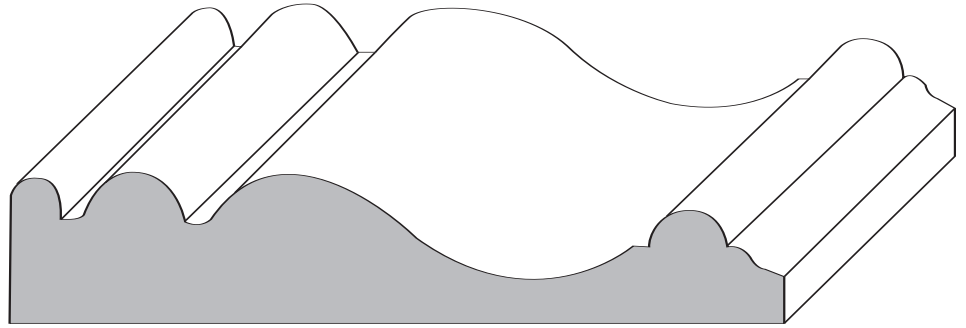

C-R270U
 $\frac{3}{4} \times 4$

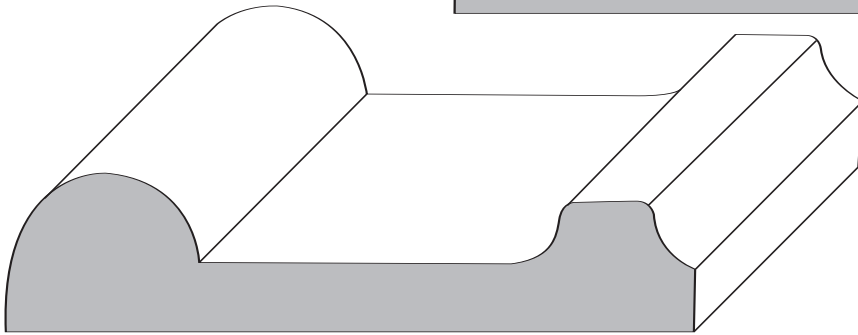

C-GROSS
 $\frac{3}{16} \times 3\frac{1}{2}$

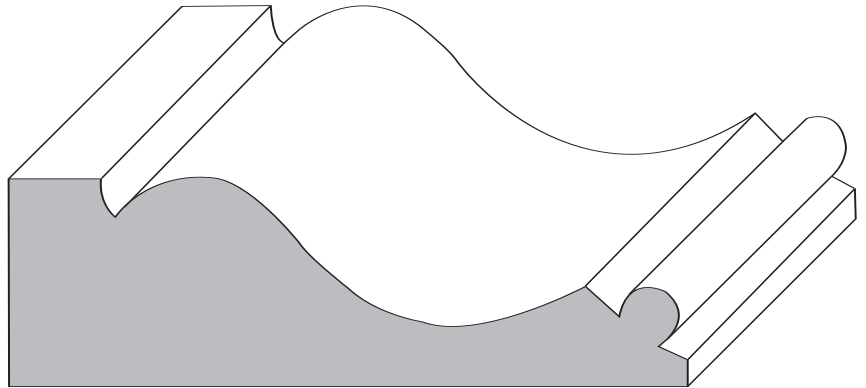

C-NJ177
 $1\frac{1}{16} \times 3\frac{1}{2}$

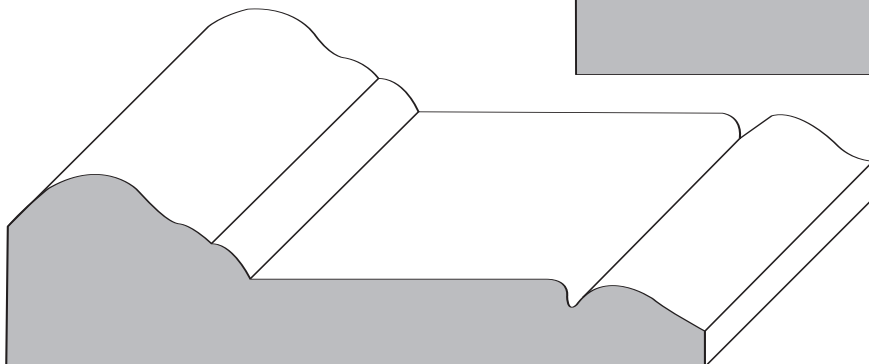

C-WP460
 $1 \times 3\frac{7}{8}$

**To Place an Order,
Call:
1-608-698-6645**

To Place an Order - Call:
1-608-698-6645

CASING

To Place an Order,
Call:
1-608-698-6645

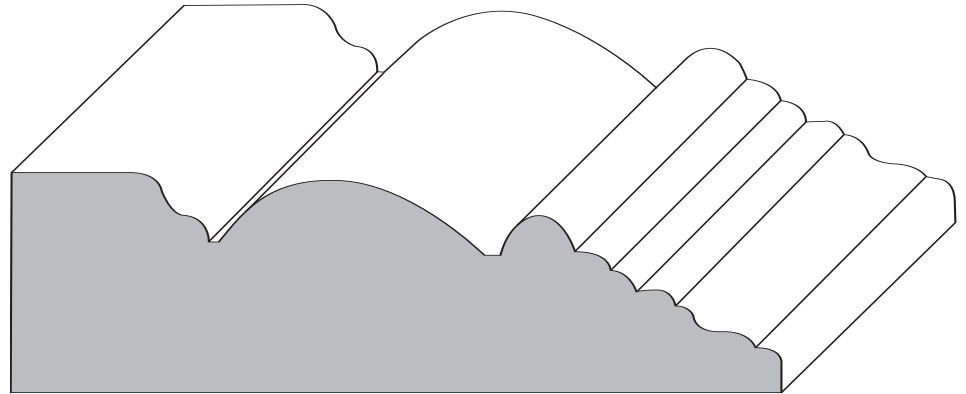

C-MD065
1 1/8 x 4

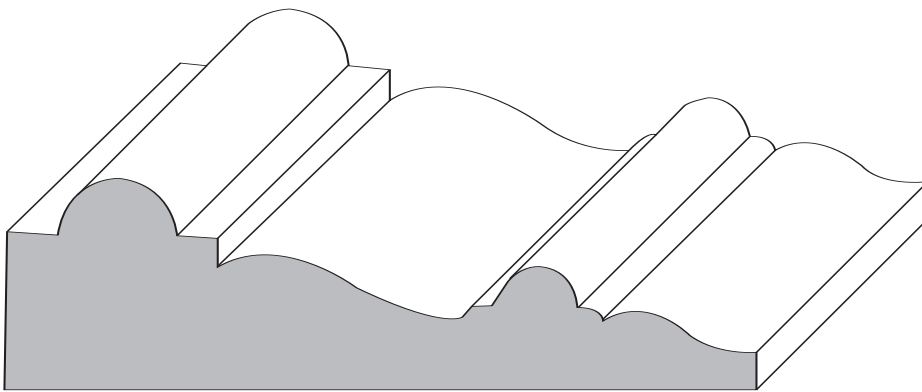

C-RR380
1 x 3 5/8

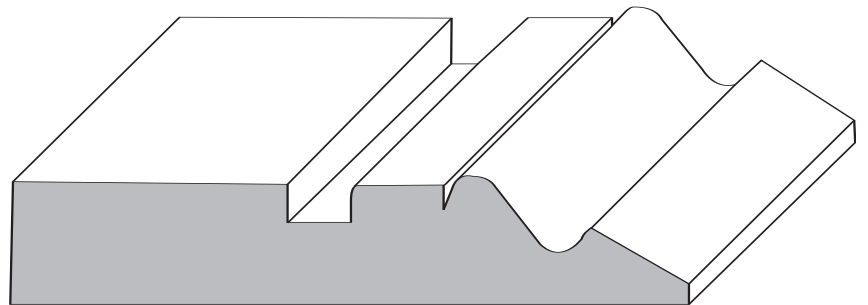

C-SC303
5/8 x 3 1/2

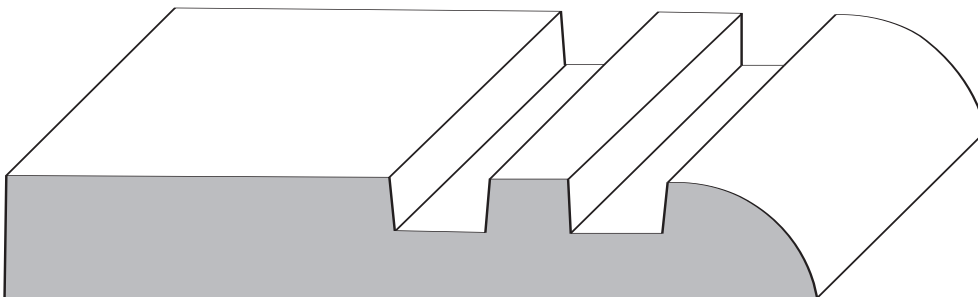

C-MD415
5/8 x 4 1/8

To Place an Order,
Call:
1-608-698-6645

CASING

**To Place an Order - Call:
1-608-698-6645**

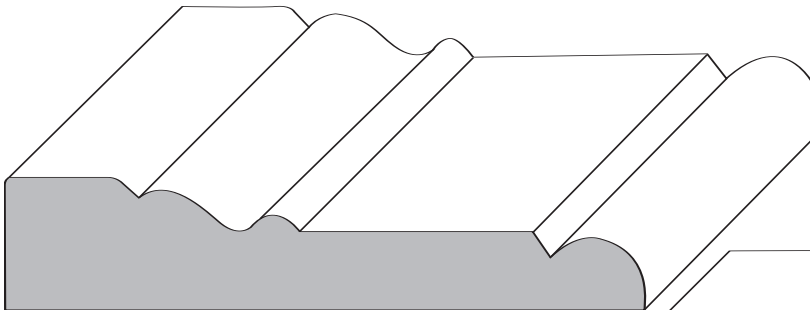

C-HERIT
 $1\frac{1}{16} \times 3\frac{1}{4}$

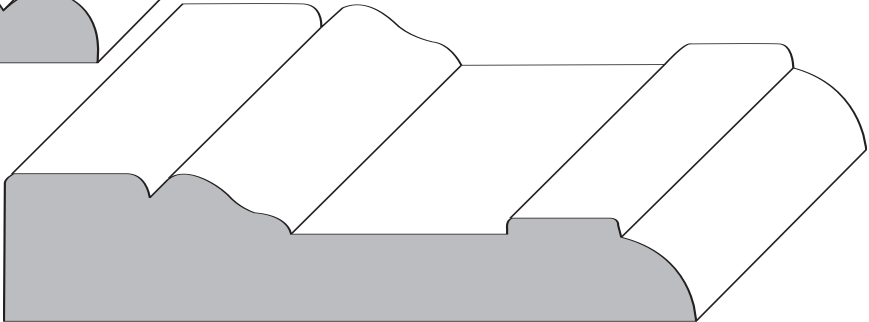

C-NJ128
 $\frac{3}{4} \times 3\frac{9}{16}$

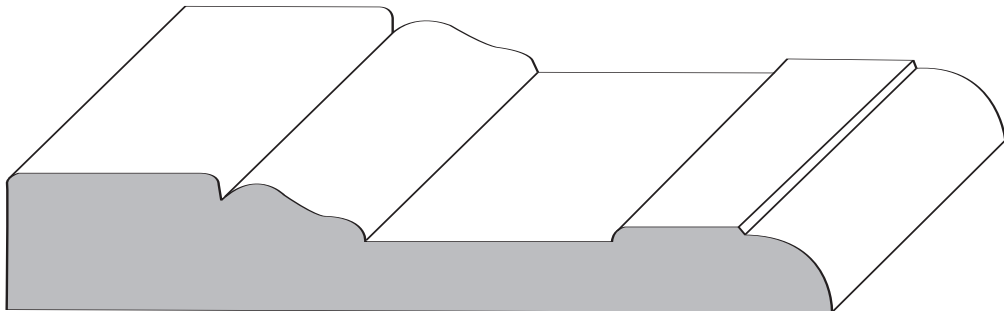

C-DI235
 $1\frac{1}{16} \times 4\frac{1}{4}$

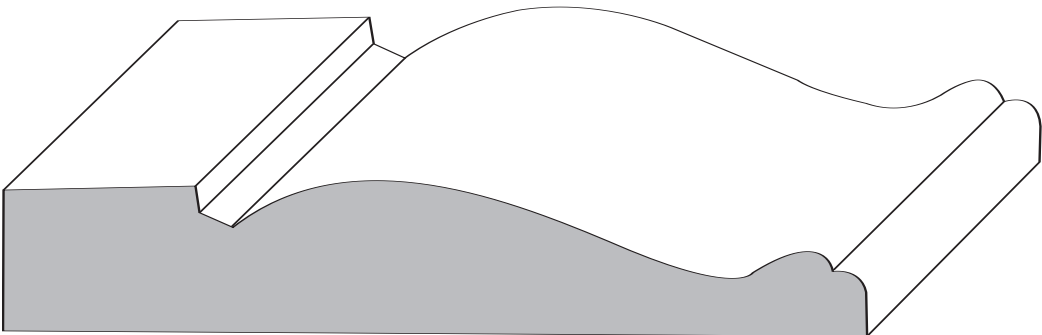

C-SM450
 $\frac{3}{4} \times 4\frac{1}{2}$

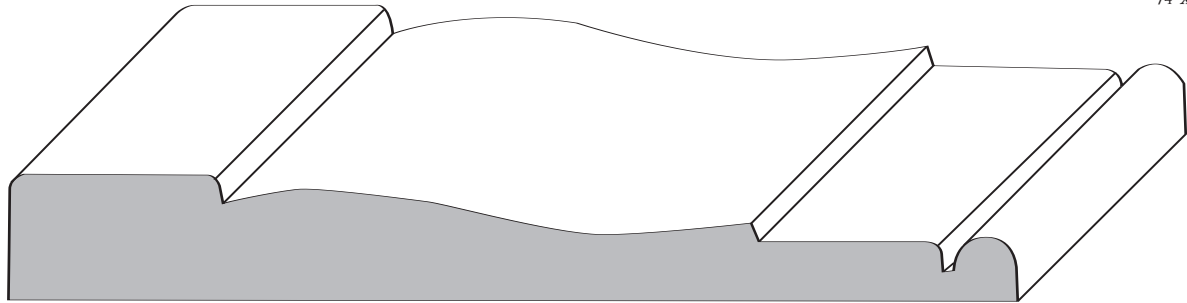

C-PM931
 $\frac{5}{8} \times 5\frac{1}{4}$

**To Place an Order,
Call:
1-608-698-6645**

To Place an Order,
Call:
1-608-698-6645

CASING

To Place an Order,
Call:
1-608-698-6645

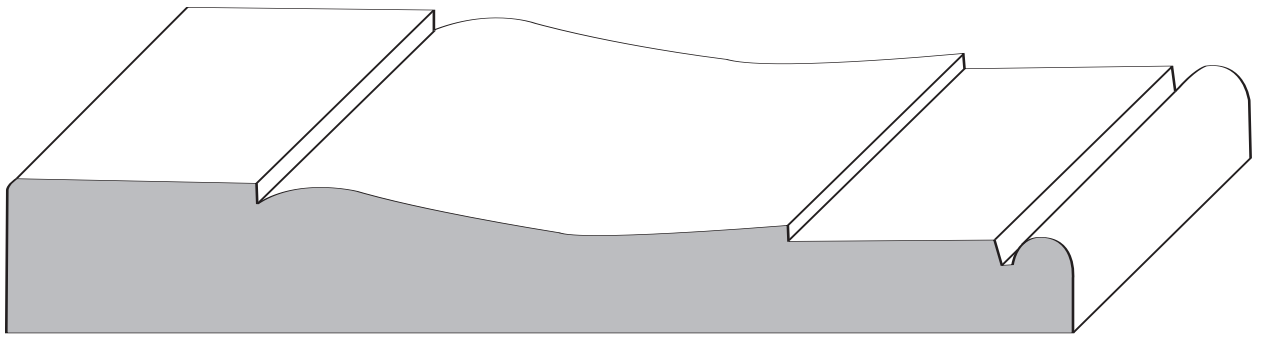

C-SM315
 $\frac{3}{4}$ x $5\frac{1}{2}$

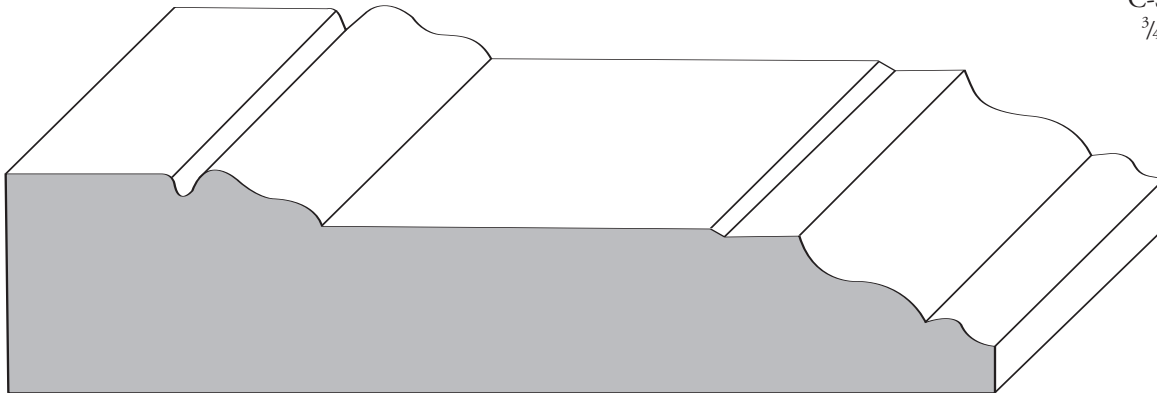

C-TH141
 $1\frac{1}{8}$ x $5\frac{1}{8}$

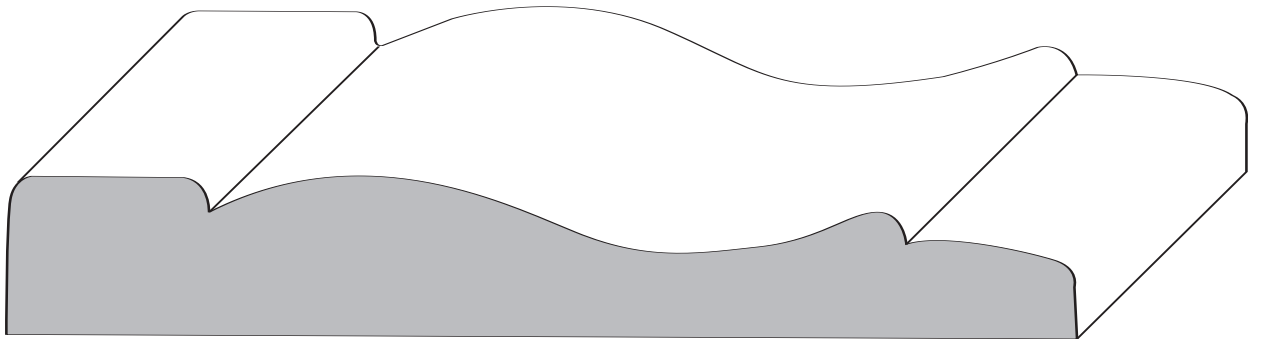

C-PA550
 $\frac{13}{16}$ x $5\frac{1}{2}$

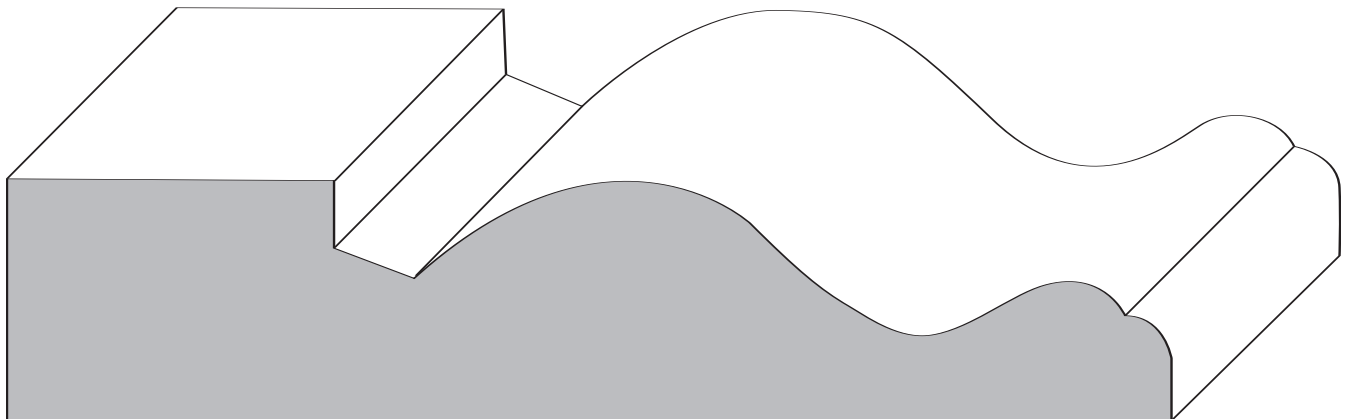

C-SM600
 $1\frac{1}{4}$ x 6

**To Place an Order - Call:
1-608-698-6645**

CASING

**To Place an Order - Call:
1-608-698-6645**

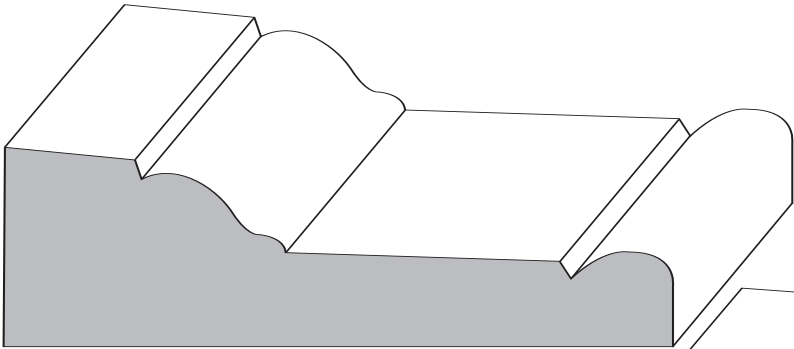

WM097
1 x 3½

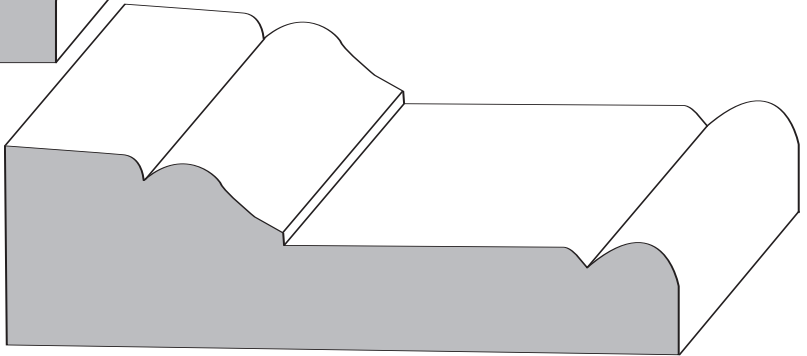

C-EC20
1 x 3½

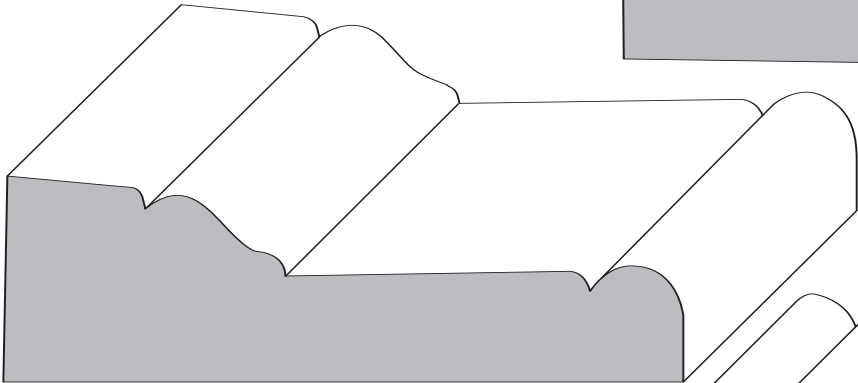

C-SSD97
1½ x 3⅞

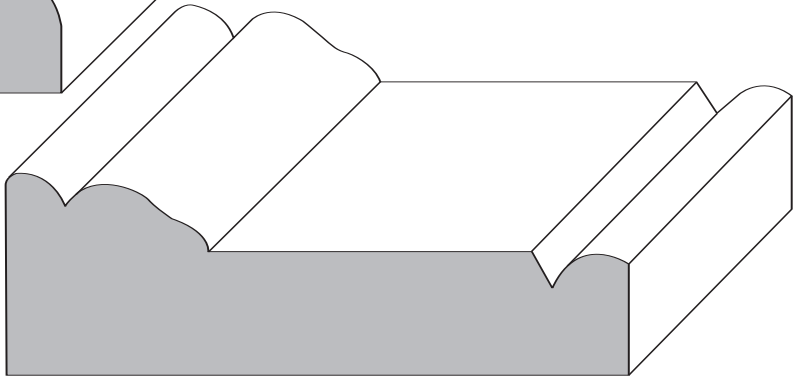

C-DYKSP
1 x 3¼

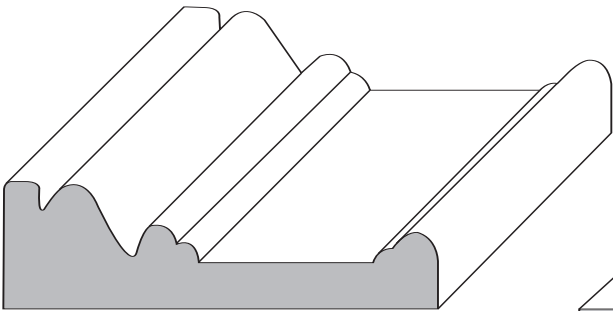

T-RB1
⅝ x 2¼

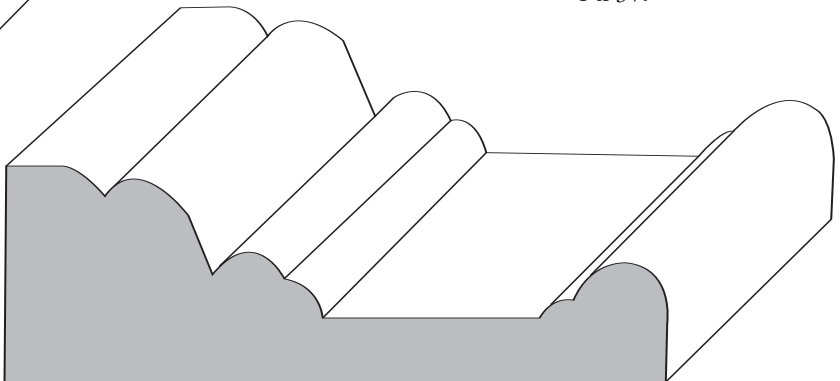

C-TT302
1½ x 3⅞

**To Place an Order,
Call:
1-608-698-6645**

CASING

To Place an Order,
Call:
1-608-698-6645

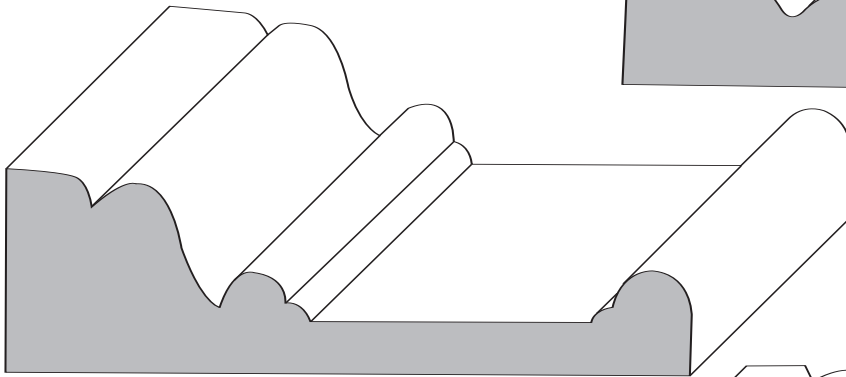

C-DHOWE
1 x 3½

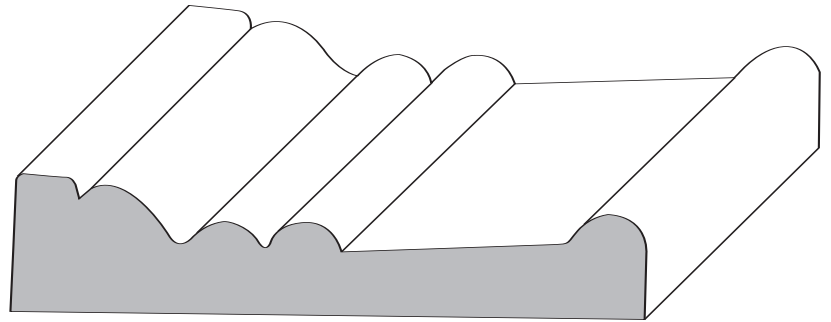

C-HSD-1
1¼ x 3¼

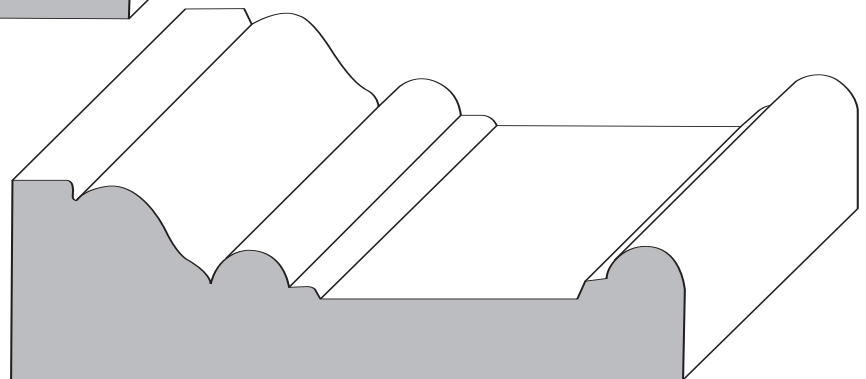

T-RB300
1 x 3½

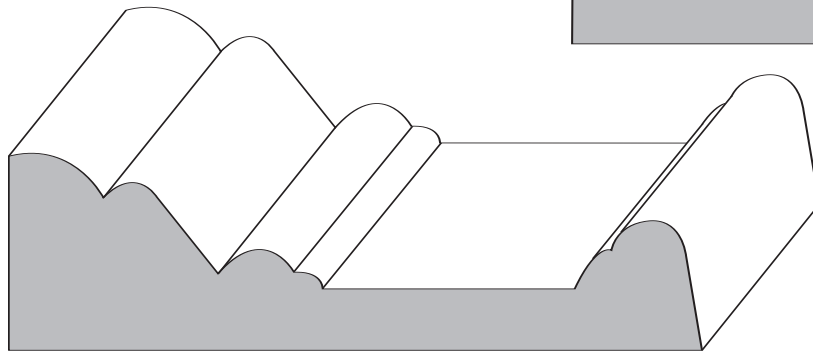

C-MSAL3
1 x 3½

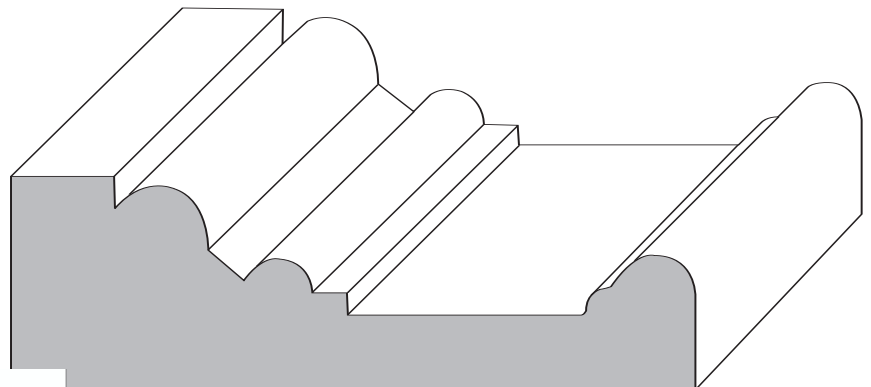

C-P2575
1⅛ x 3½

**To Place an Order - Call:
1-608-698-6645**

**To Place an Order - Call:
1-608-698-6645**

To Place an Order,
Call:
1-608-698-6645

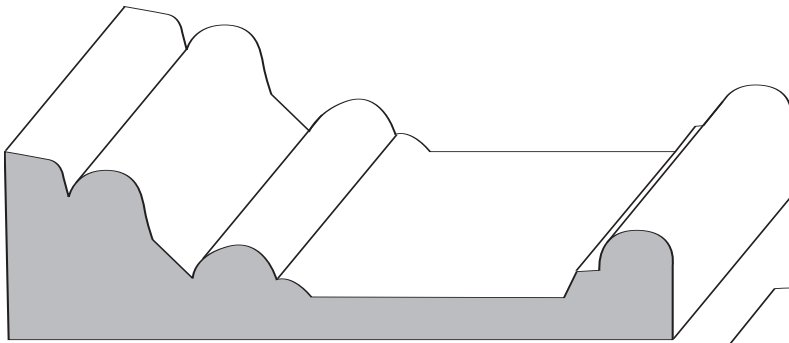

C-EC1
3½ x 1

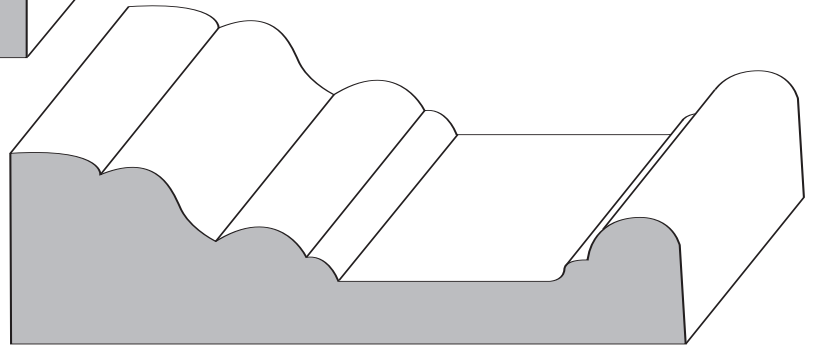

C-ECMD1
1 x 3½

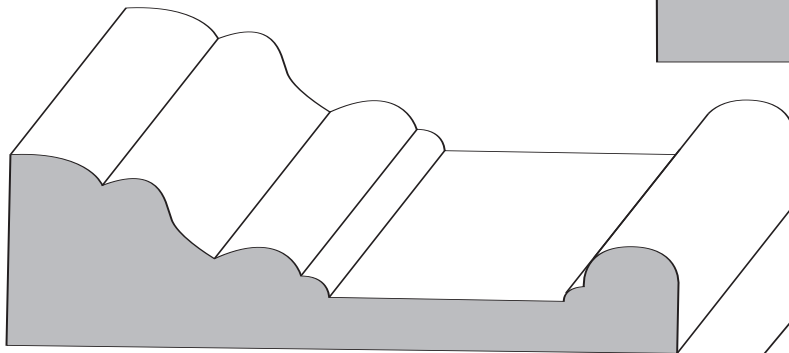

C-RB3M
1 x 3½

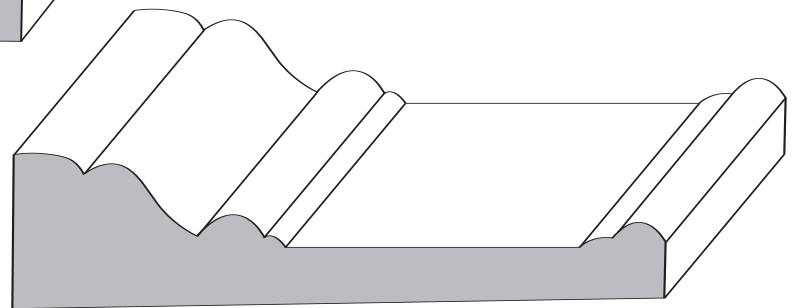

C-HB-78
7/8 x 3½

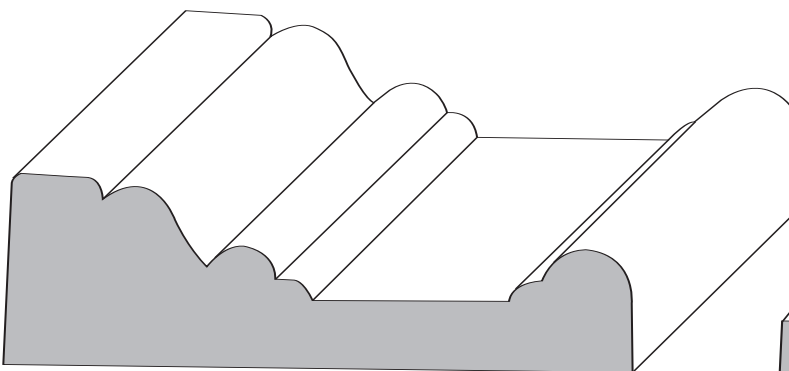

C-VS300
1 x 3¼

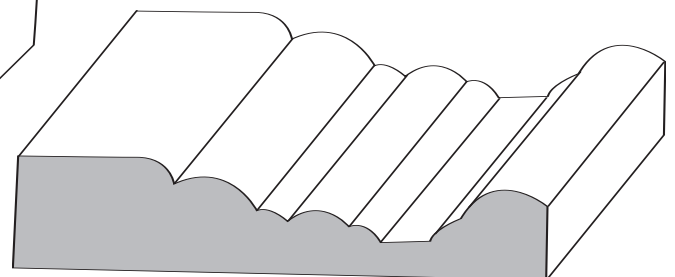

C-HS-2
5/8 x 2¾

CASING

To Place an Order,
Call:
1-608-698-6645

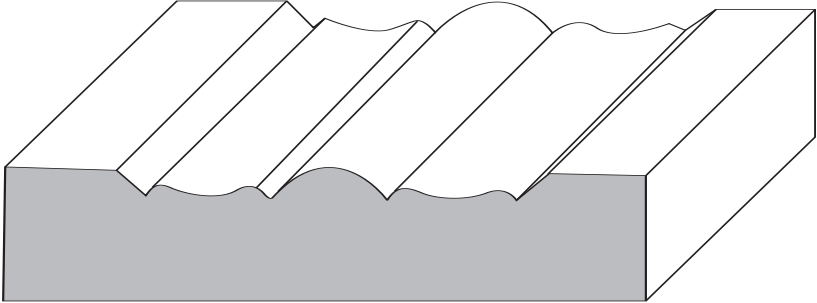

C-DC358
 $\frac{11}{16} \times 3\frac{3}{8}$

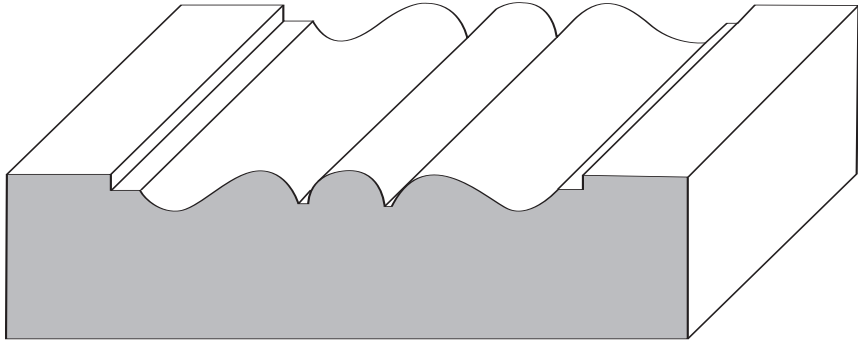

C-SS281
 $\frac{3}{4} \times 4$

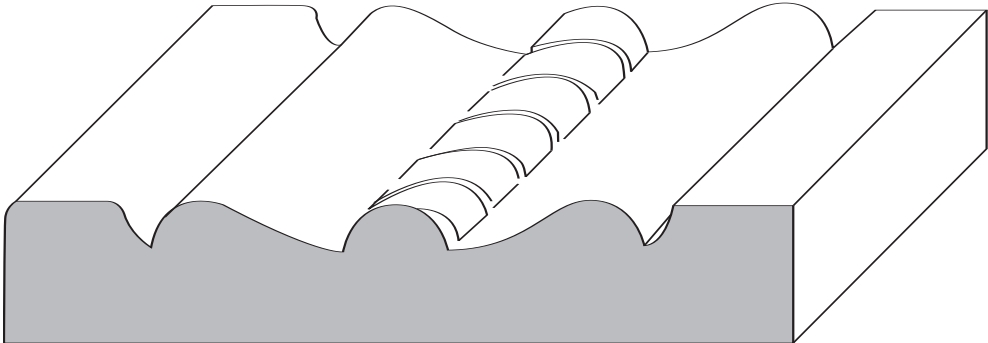

C-RR272
 $\frac{3}{4} \times 4$

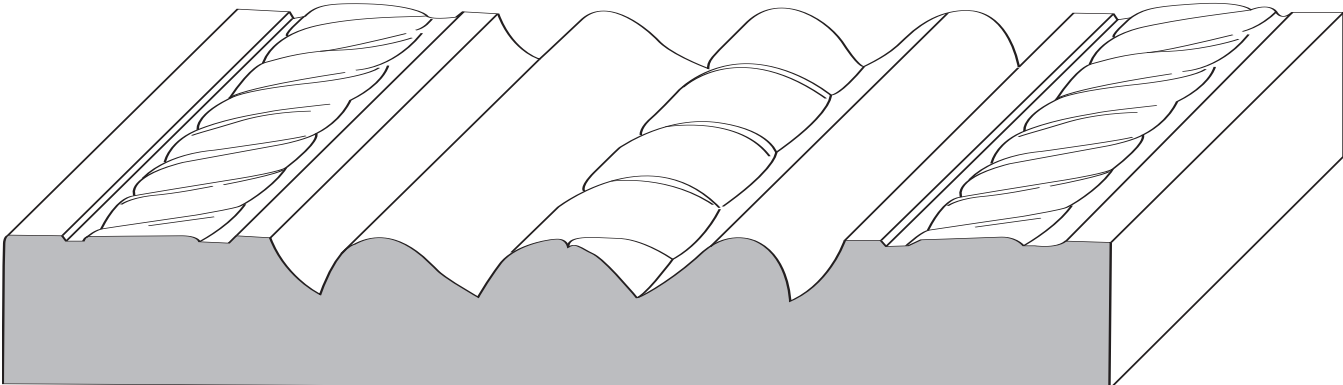

C-RR271
 $\frac{3}{4} \times 5\frac{3}{4}$

**To Place an Order - Call:
1-608-698-6645**

CASING

To Place an Order,
Call:
1-608-698-6645

To Place an Order - Call:
1-608-698-6645

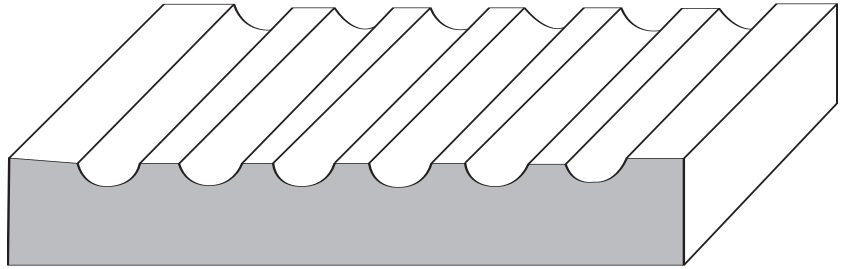

C-B1002
 $\frac{1}{2} \times 3\frac{9}{16}$

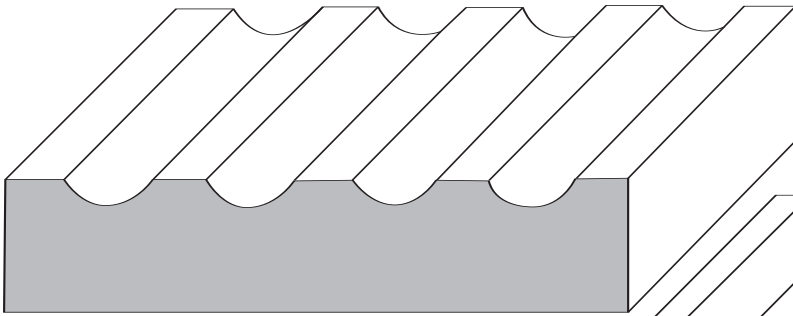

C-FLUTT
 $\frac{11}{16} \times 3\frac{1}{4}$

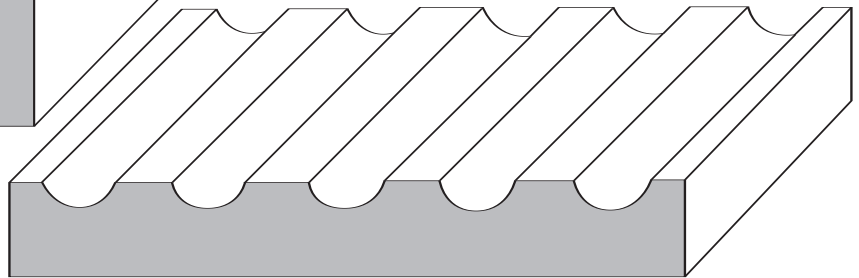

T-SL311
 $\frac{1}{2} \times 3\frac{1}{2}$

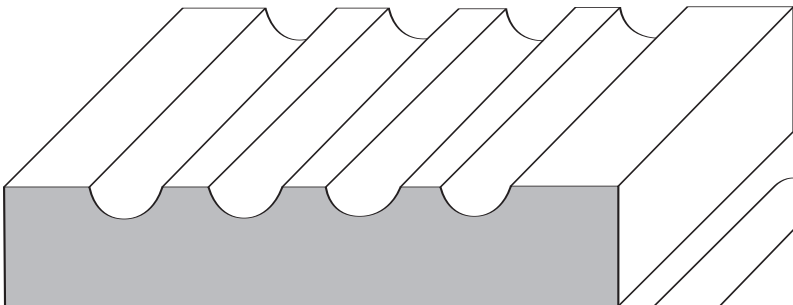

C-RRL05
 $\frac{5}{8} \times 3\frac{1}{4}$

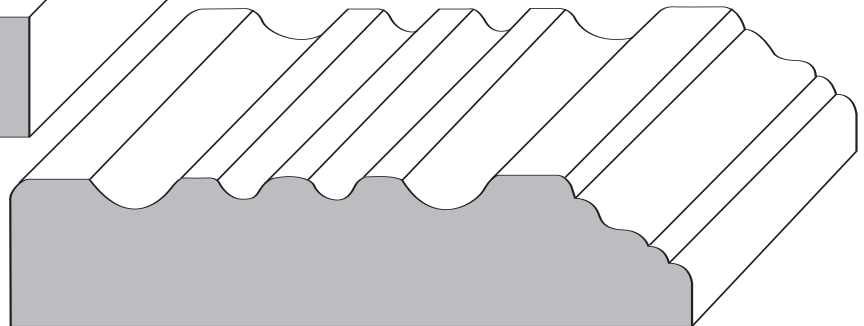

C-HI312
 $\frac{3}{4} \times 3\frac{1}{2}$

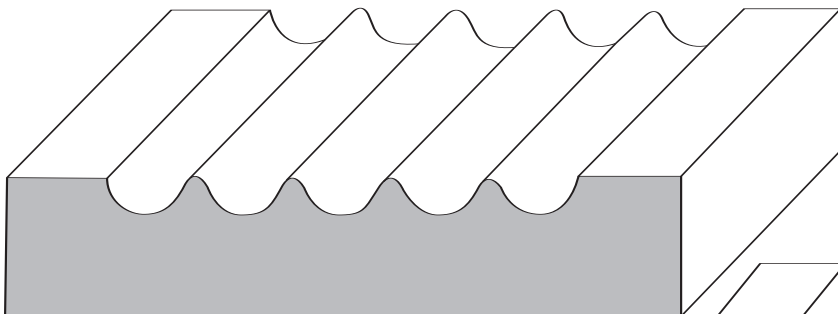

C-CL312
 $\frac{3}{4} \times 3\frac{1}{2}$

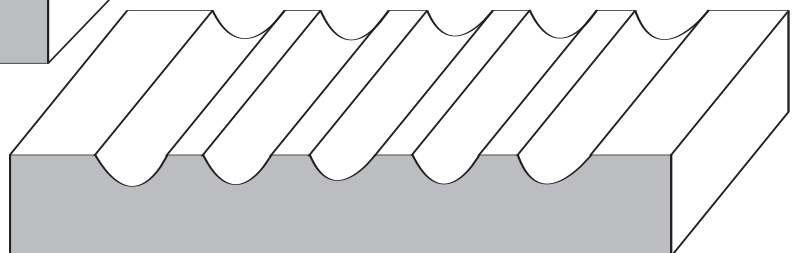

C-RB6F
 $\frac{5}{8} \times 3\frac{1}{2}$

To Place an Order,
Call:
1-608-698-6645

CASING

To Place an Order,
Call:
1-608-698-6645

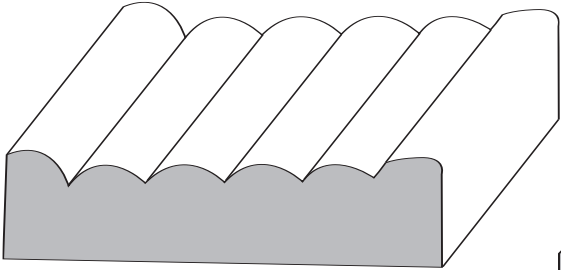

C-1002M
 $\frac{9}{16} \times 2\frac{1}{4}$

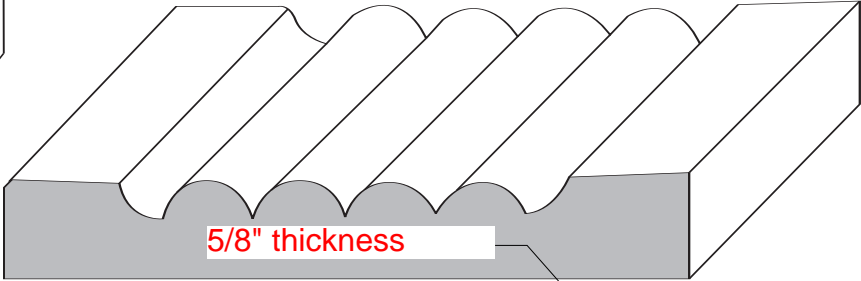

C-M15
 $\frac{1}{2} \times 3\frac{1}{2}$

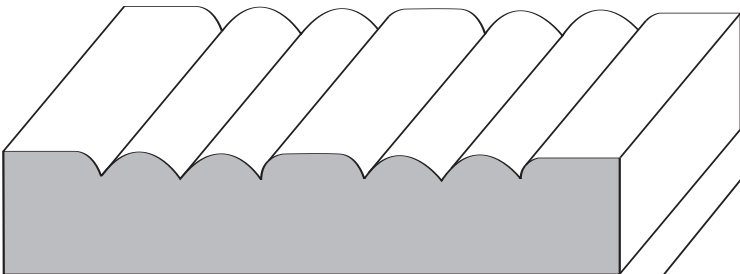

C-EC14R
 $\frac{5}{8} \times 3\frac{1}{4}$

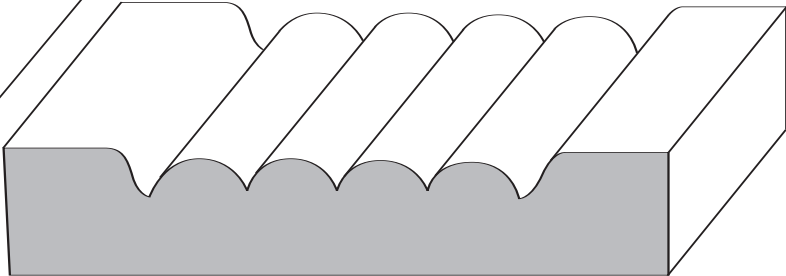

C-RB6R
 $\frac{5}{8} \times 3\frac{1}{2}$

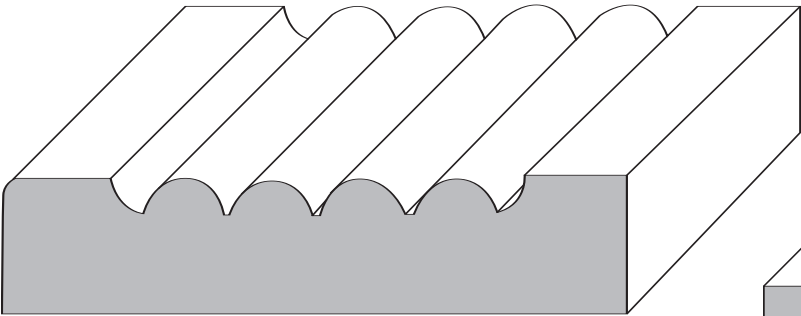

C-RR260
 $1\frac{1}{16} \times 3\frac{1}{4}$

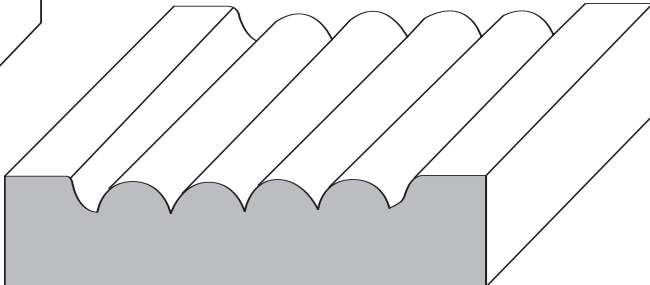

C-RR255
 $\frac{9}{16} \times 2\frac{1}{2}$

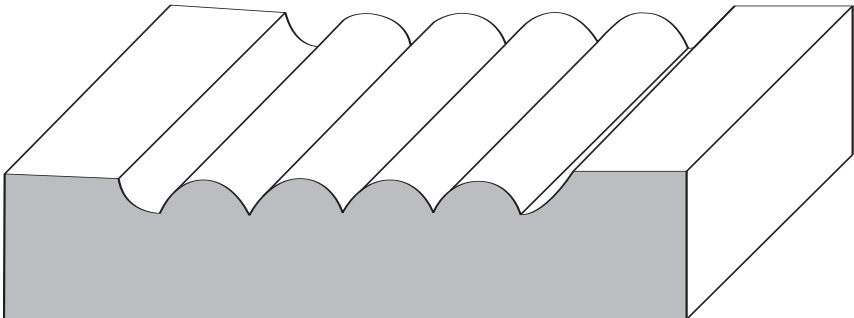

C-RAM15
 $\frac{3}{4} \times 3\frac{1}{2}$

**To Place an Order - Call:
1-608-698-6645**

**To Place an Order - Call:
1-608-698-6645**

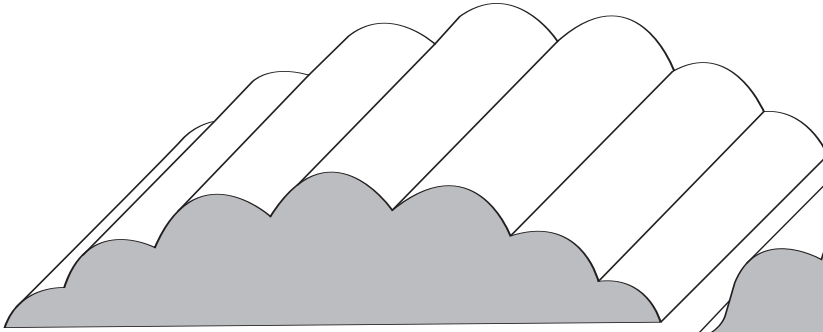

C-M14
 $1\frac{3}{16} \times 3\frac{3}{8}$

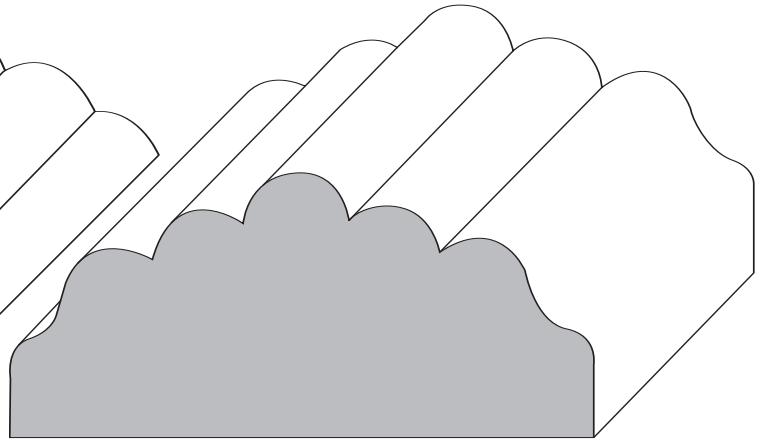

C-RR300
 $1\frac{5}{16} \times 3$

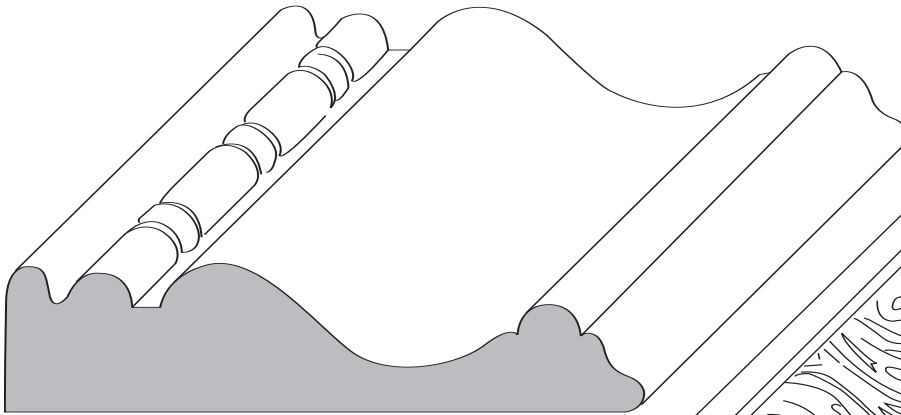

C-RR265
 $\frac{3}{4} \times 3\frac{1}{4}$

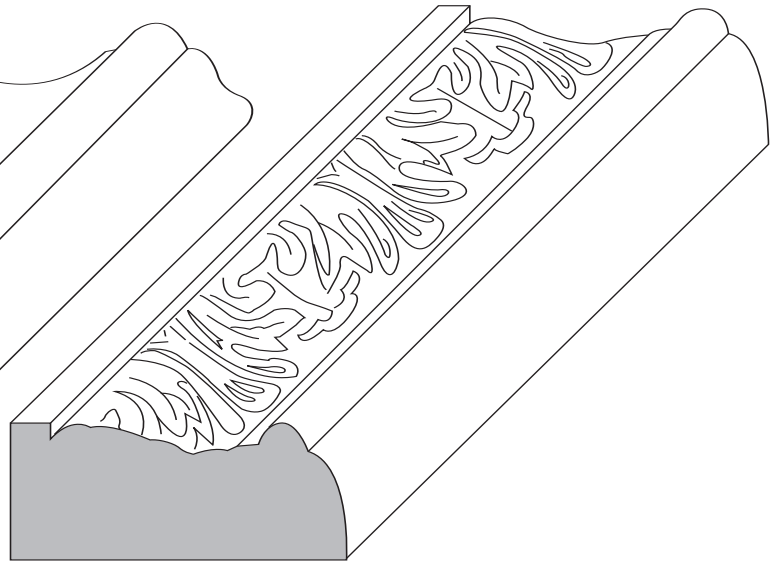

C-EM615
 $\frac{3}{4} \times 1\frac{3}{4}$

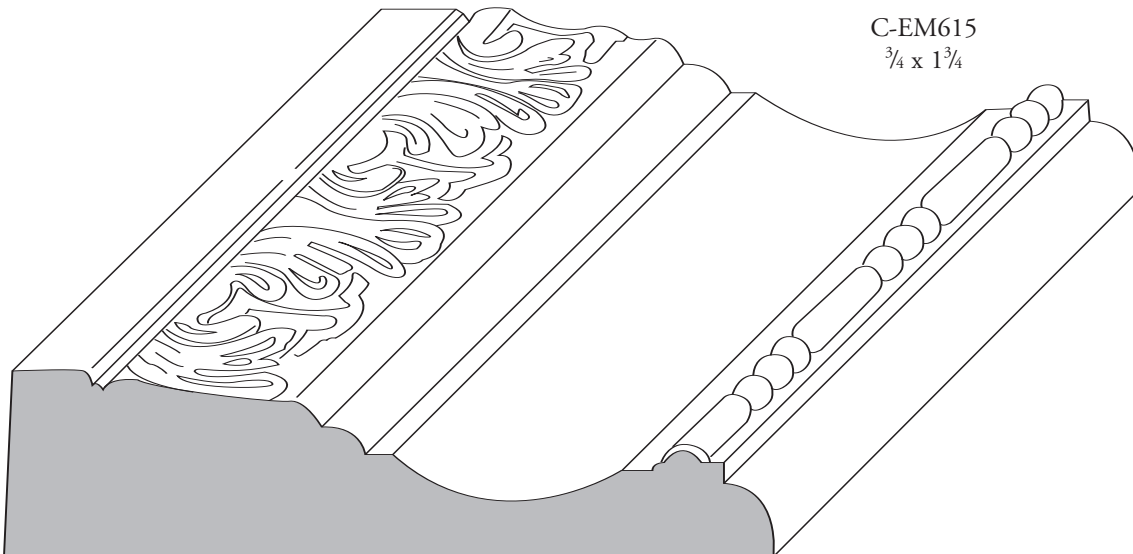

C-DS408
 1×4

To Place an Order,
Call:
1-608-698-6645

To Place an Order - Call: 1-608-698-6645

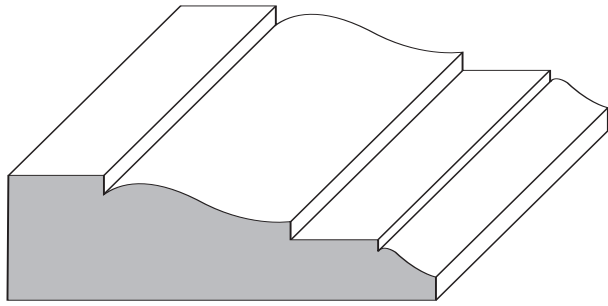

T-WM366
 $1\frac{1}{16} \times 2\frac{1}{4}$

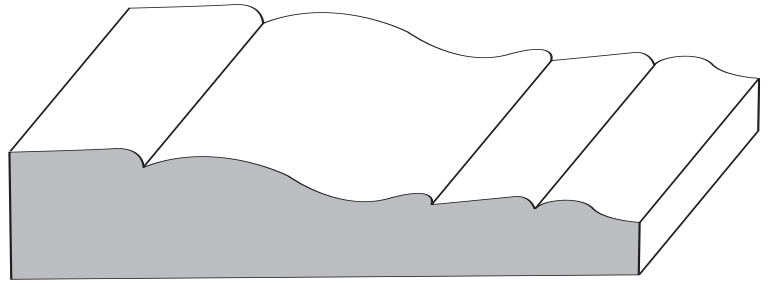

C-EC361
 $1\frac{1}{16} \times 3\frac{3}{4}$

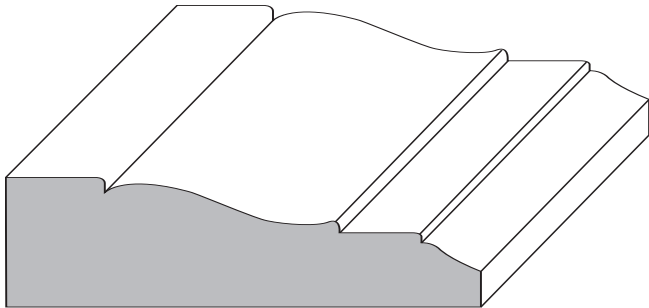

T-WM361
 $1\frac{1}{16} \times 2\frac{1}{2}$

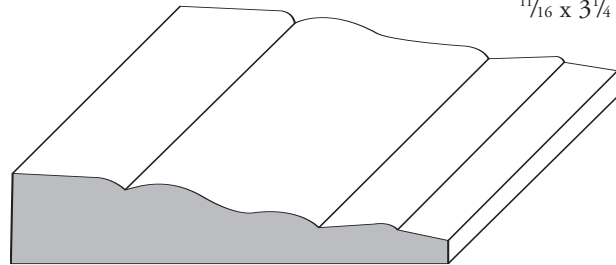

T-FL366
 $7\frac{7}{16} \times 2\frac{1}{4}$

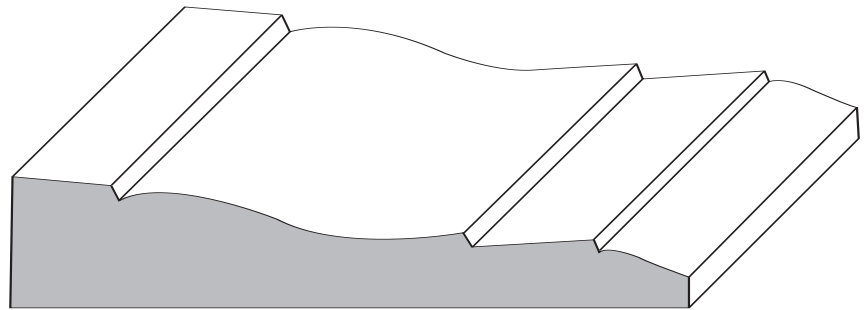

C-L8753
 $\frac{5}{8} \times 3\frac{1}{2}$

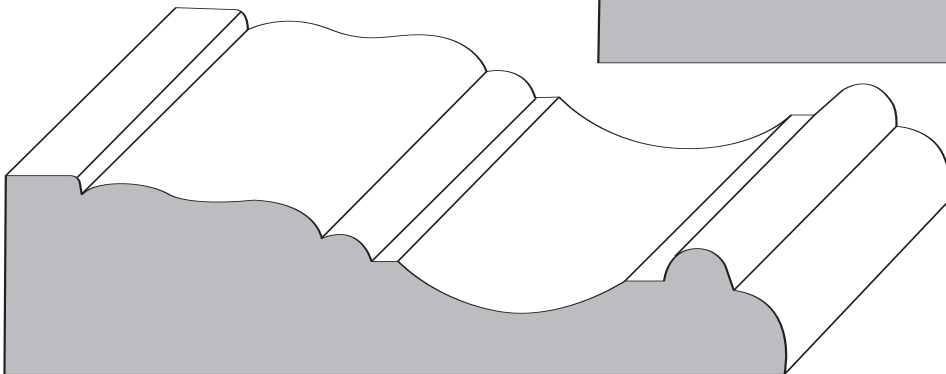

C-DS400
1 x 4

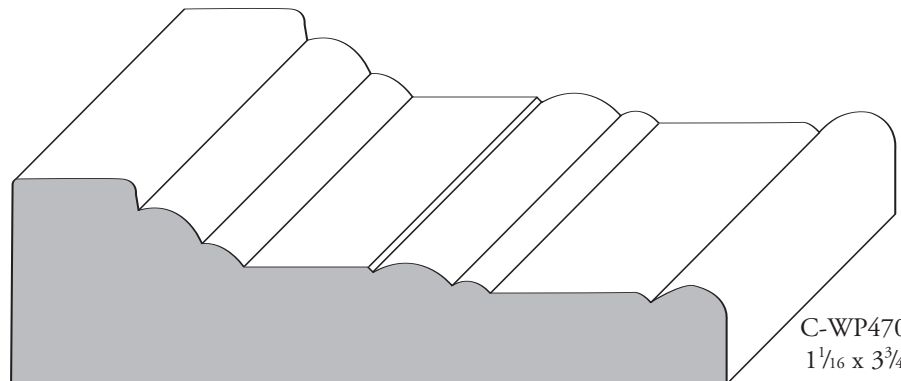

C-WP470
 $1\frac{1}{16} \times 3\frac{3}{4}$

To Place an Order,
Call:
1-608-698-6645

**To Place an Order - Call:
1-608-698-6645**

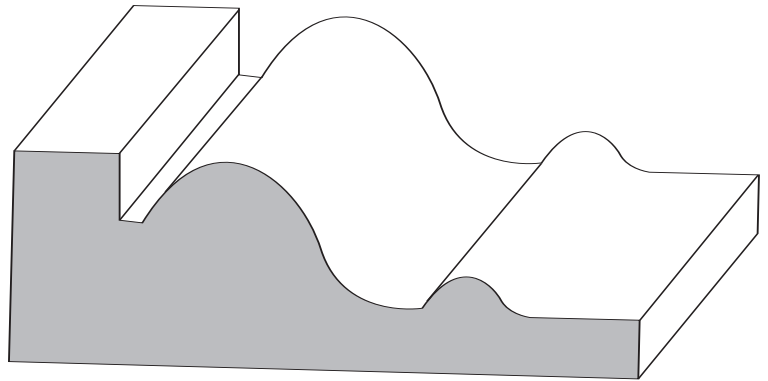

C-SPRAT
1 1/8 x 3 1/4

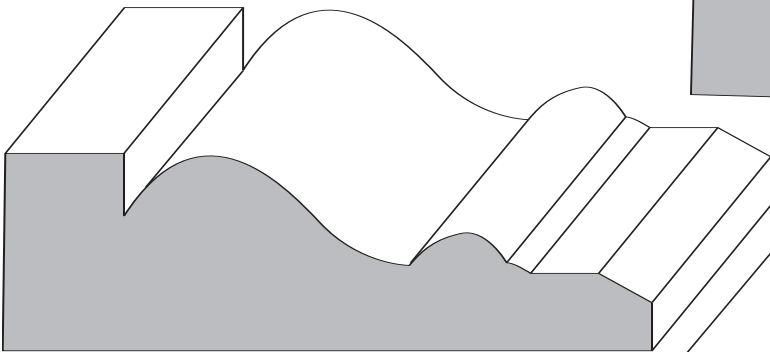

C-SPRTL
1 x 3 1/2

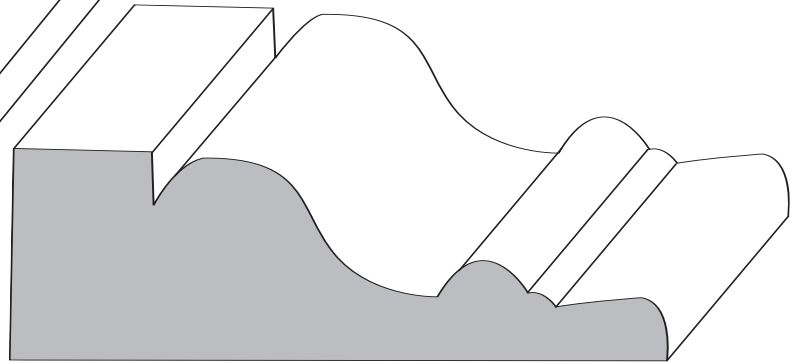

C-M1661
1 1/8 x 3 3/8

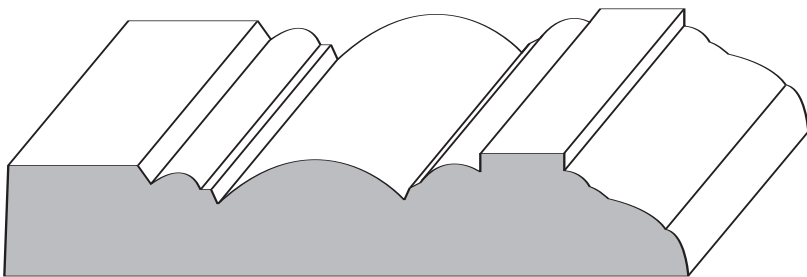

C-HB341
5/8 x 3 1/2

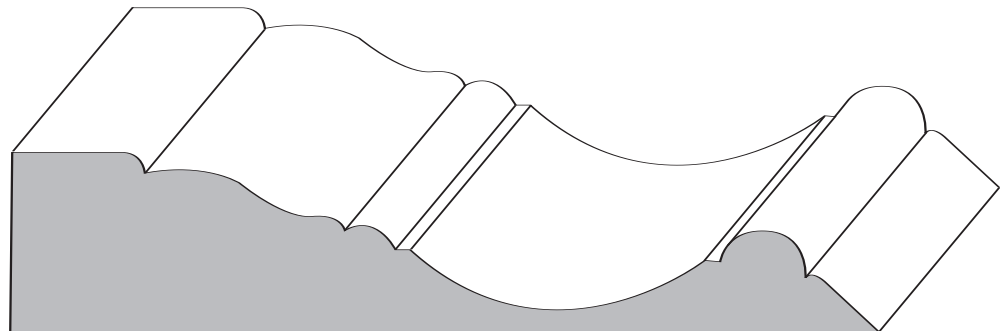

C-441WM
1 1/16 x 4 1/2

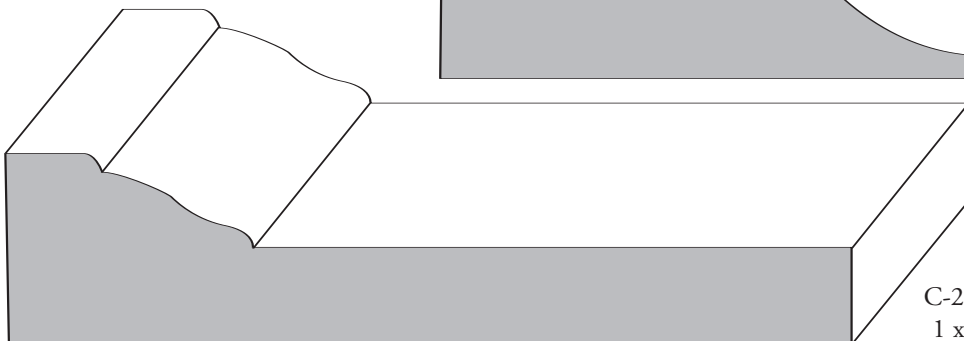

C-281-4
1 x 4 1/2

**To Place an Order,
Call:
1-608-698-6645**