

**To Place an Order - Call:
1-608-698-6645**

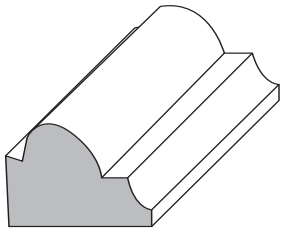

T-SL401
 $\frac{1}{2} \times \frac{3}{4}$

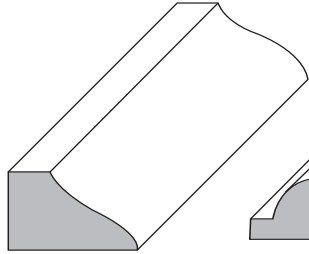

C-RRL06
 $\frac{3}{8} \times \frac{5}{8}$

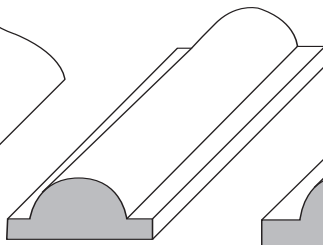

C-TH075
 $\frac{5}{16} \times \frac{3}{4}$

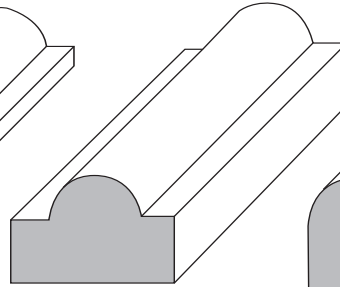

C-TH080
 $\frac{9}{16} \times \frac{7}{8}$

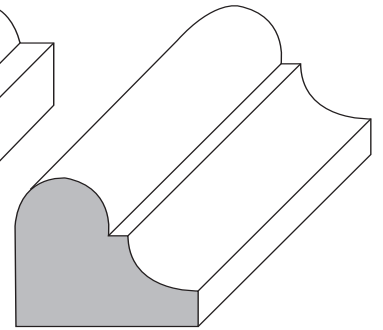

C-GM13
 $\frac{3}{4} \times 1$

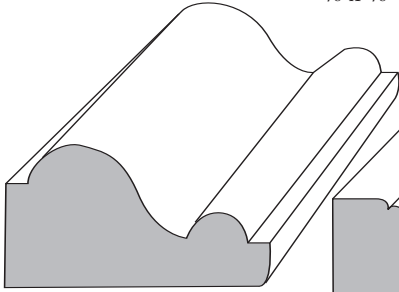

C-35955
 $\frac{11}{16} \times 1\frac{5}{16}$

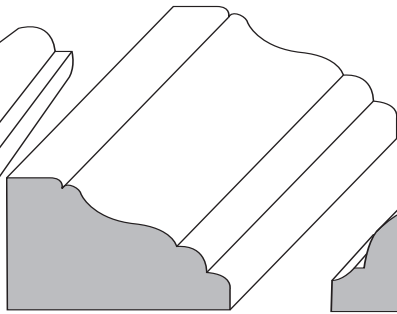

C-RRL07
 $\frac{5}{8} \times 1\frac{1}{8}$

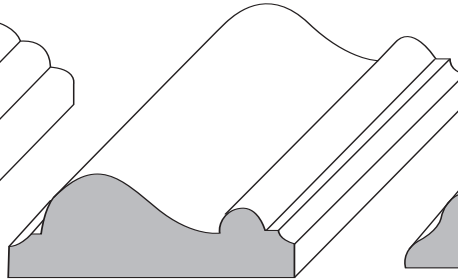

C-PS112
 $\frac{1}{2} \times 1\frac{1}{2}$

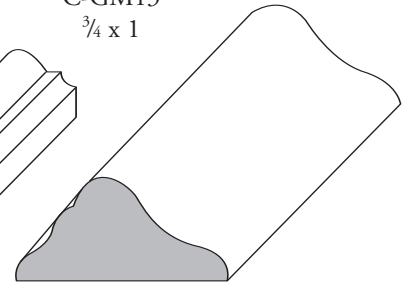

T-WM183
 $\frac{1}{2} \times 1\frac{1}{8}$

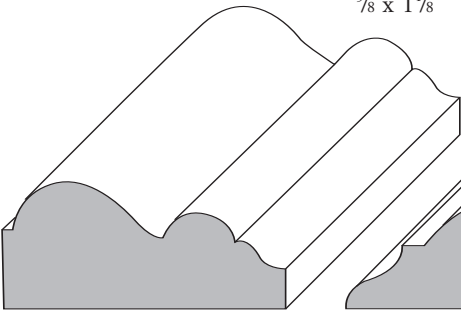

C-NJ232
 $\frac{11}{16} \times 1\frac{3}{8}$

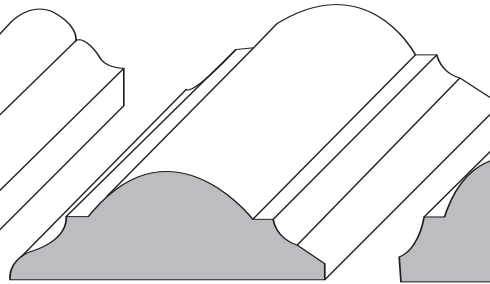

C-NJ425
 $\frac{1}{2} \times 1\frac{5}{8}$

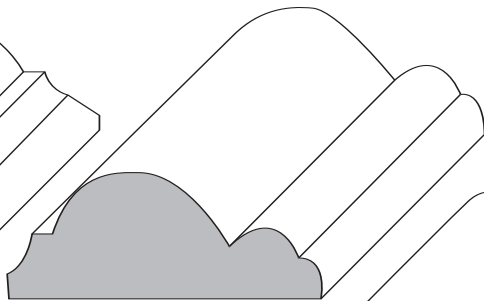

C-NJ918
 $\frac{11}{16} \times 1\frac{5}{8}$

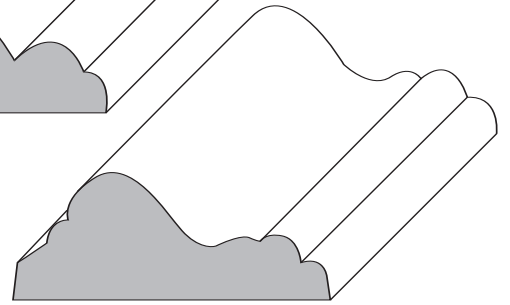

C-P8030
 $\frac{5}{8} \times 1\frac{5}{8}$

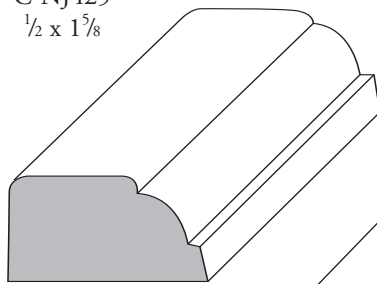

C-P9050
 $\frac{1}{2} \times 1$

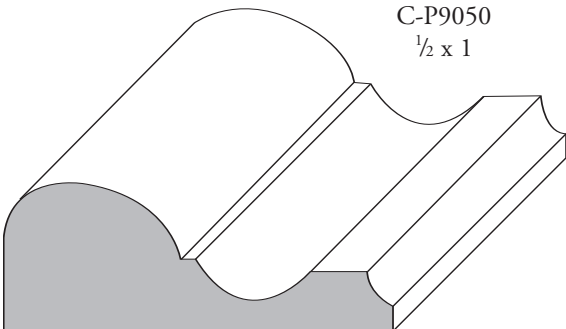

C-PM250
 $\frac{3}{4} \times 2$

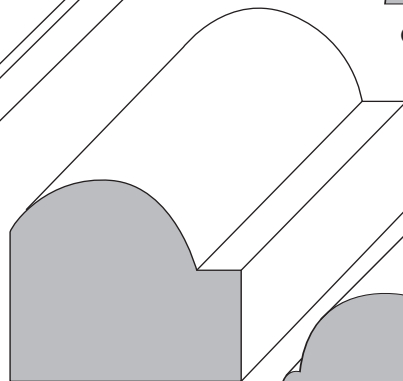

C-PO118
 $1 \times 1\frac{1}{8}$

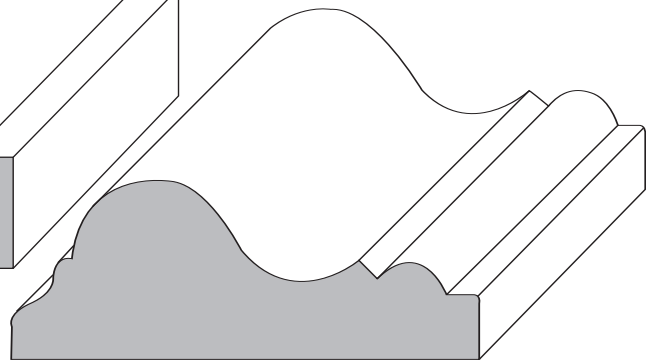

C-P8020
 $1\frac{5}{16} \times 2\frac{3}{8}$

**To Place an Order - Call:
1-608-698-6645**

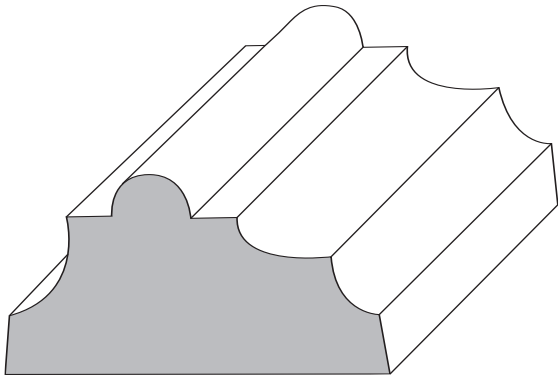

C-P9040
1 x 2

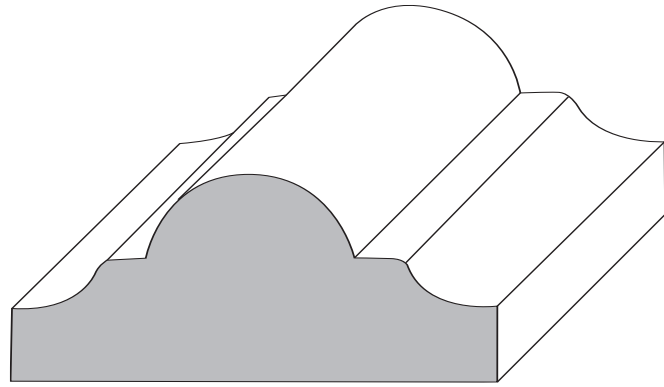

C-BO136
1¹/₁₆ x 2¹/₂

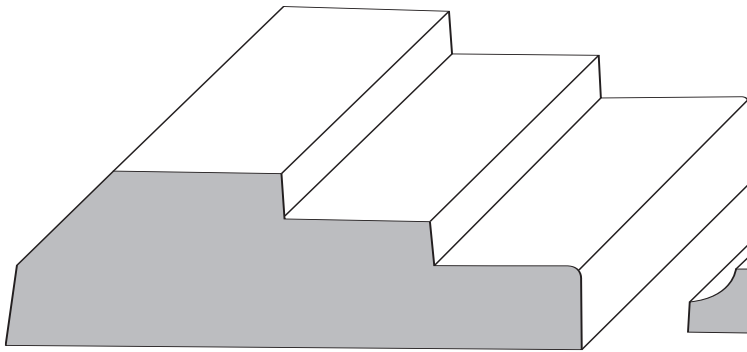

C-P7070
7⁷/₈ x 3

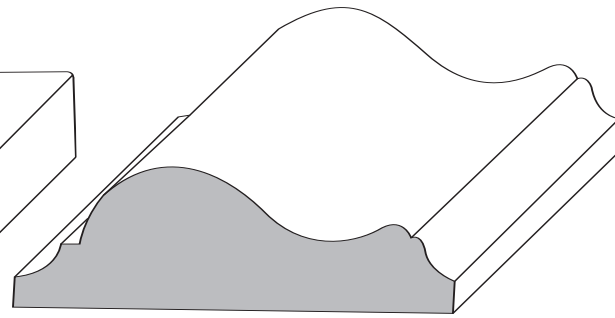

C-PM510
3³/₄ x 2¹/₄

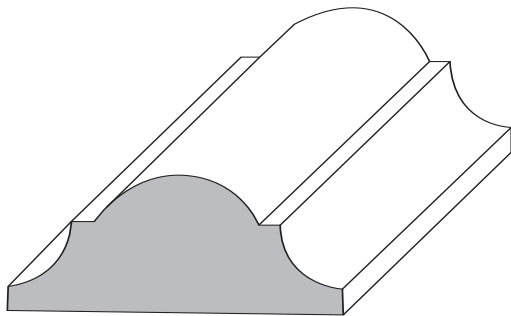

T-SL101
3³/₄ x 1³/₄

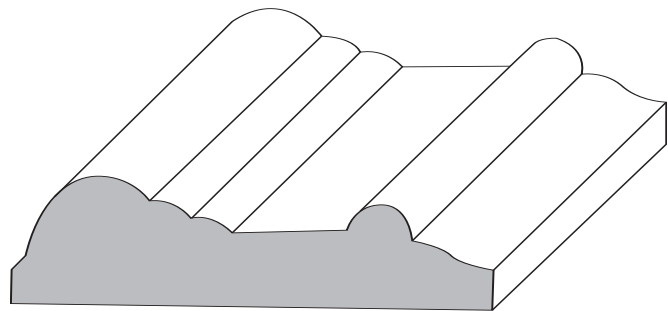

C-RLC10
1¹/₁₆ x 2¹/₂

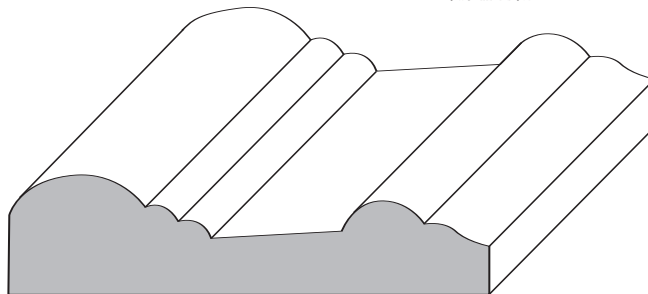

T-SL207
3³/₈ x 2¹/₂

**To Place an Order - Call:
1-608-698-6645**

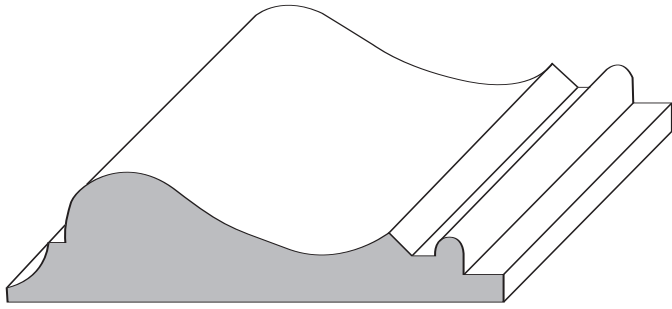

T-WM390
 $1\frac{1}{16} \times 2\frac{5}{8}$

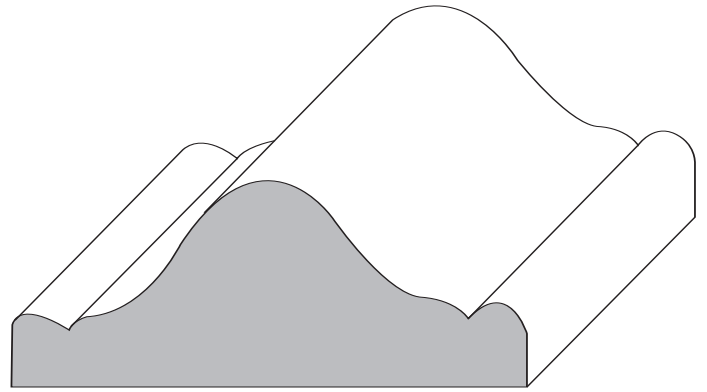

T-WM302
 $1\frac{1}{16} \times 2\frac{3}{4}$

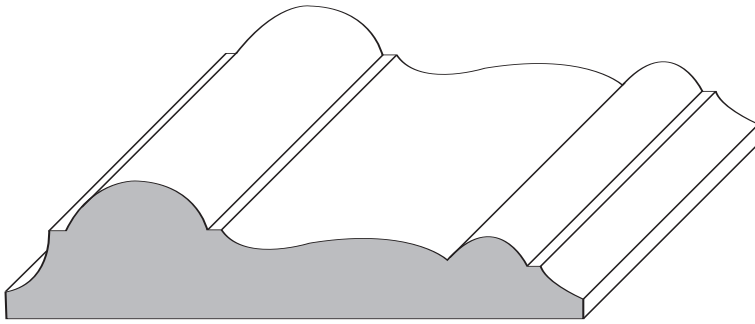

T-WM297
 $1\frac{1}{16} \times 3$

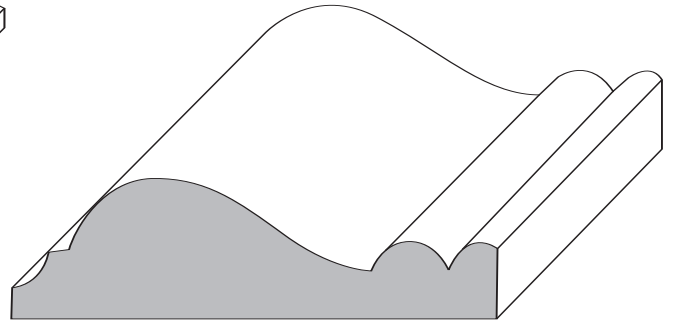

C-R242U
 $1\frac{1}{16} \times 2\frac{1}{2}$

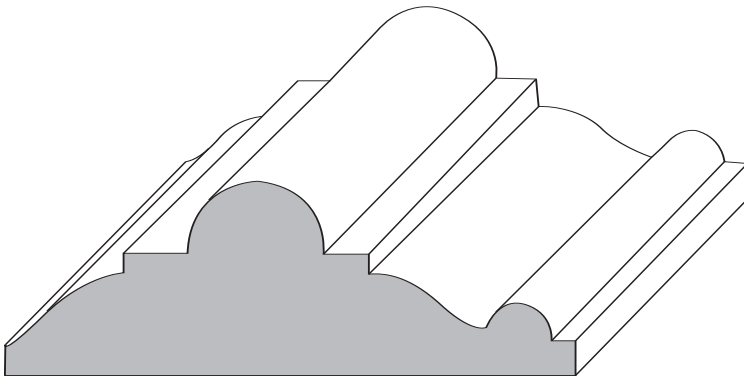

T-WM300
 1×3

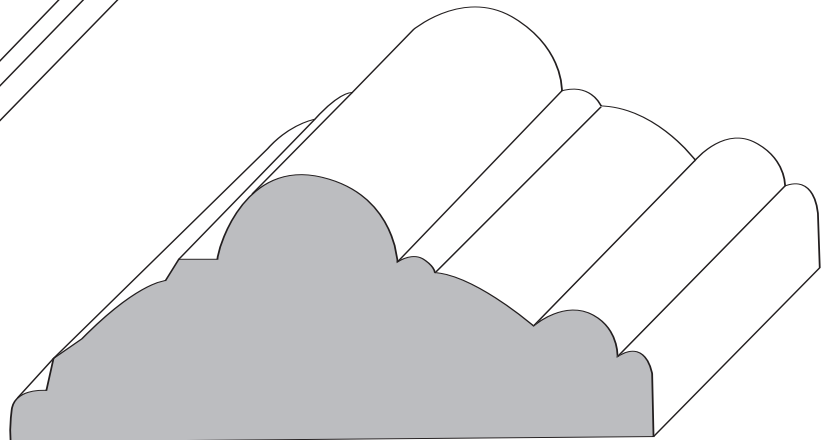

C-CT325
 $1\frac{3}{8} \times 3\frac{7}{16}$

**To Place an Order - Call:
1-608-698-6645**

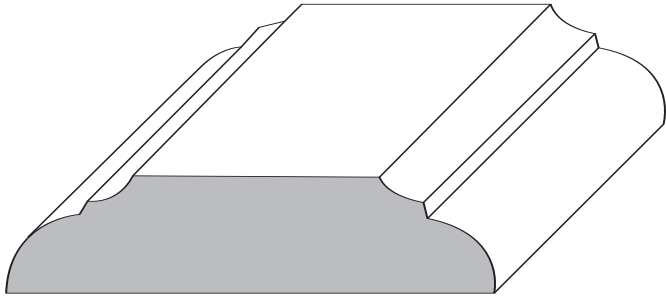

T-SL231
 $\frac{9}{16} \times 2\frac{1}{2}$

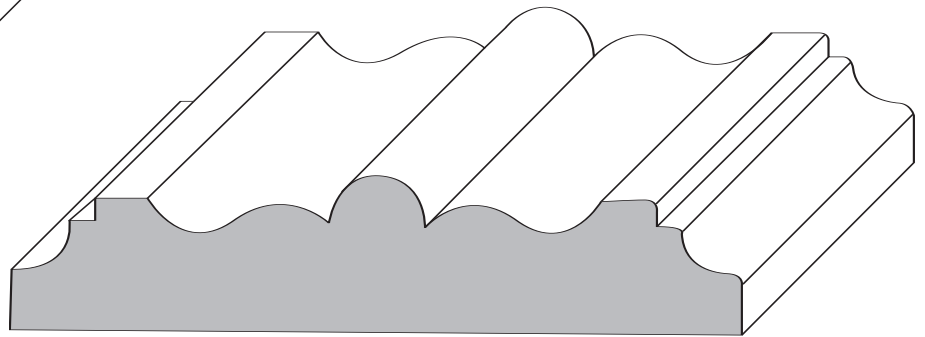

C-P9020
 $\frac{13}{16} \times 3\frac{3}{4}$

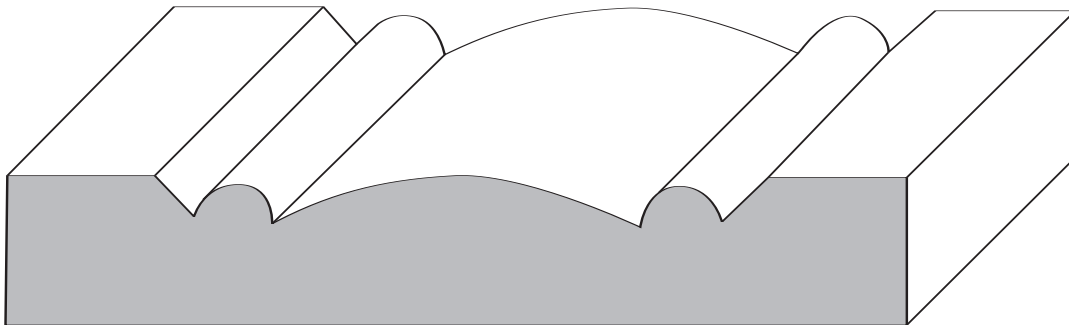

C-ES12P
 $\frac{3}{4} \times 4\frac{5}{8}$

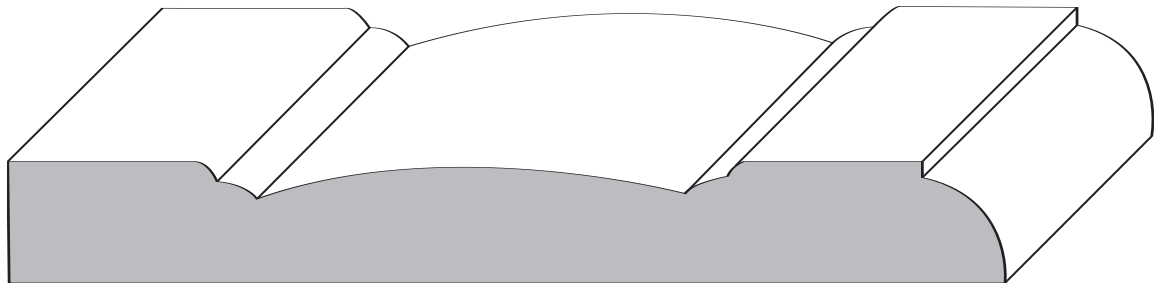

C-BA518
 $\frac{5}{8} \times 5\frac{1}{8}$

**To Place an Order - Call:
1-608-698-6645**

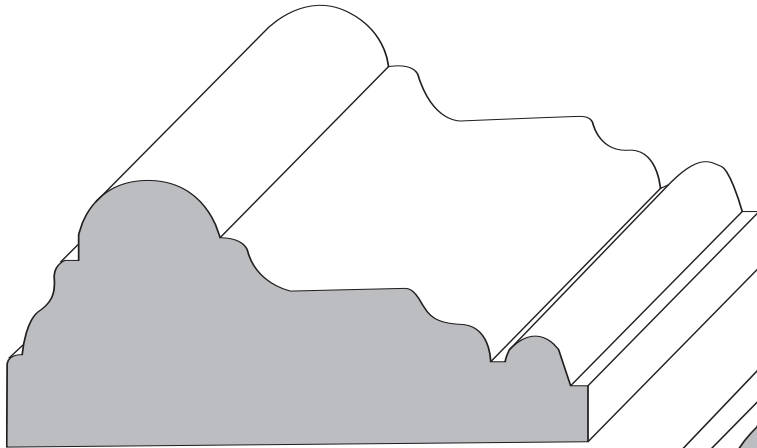

C-SI540
1⁵/₁₆ x 3

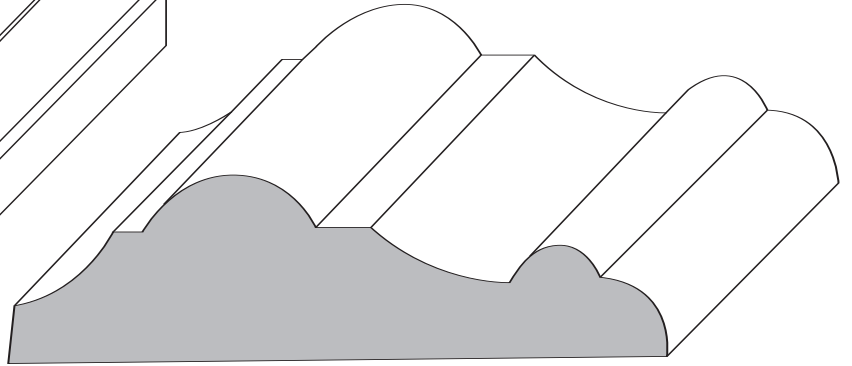

C-AH397
1¹/₈ x 3³/₈

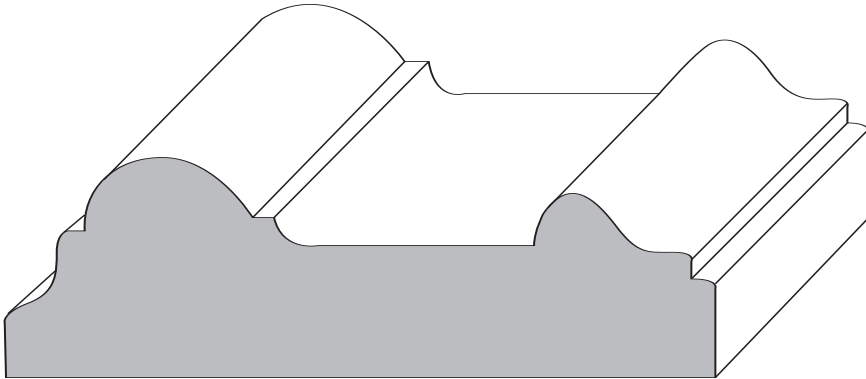

C-P9010
1¹/₈ x 3⁵/₈

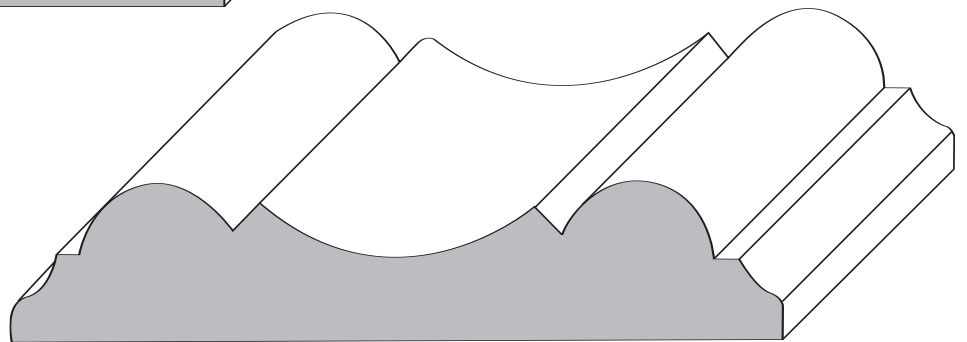

C-P8040
3³/₄ x 4

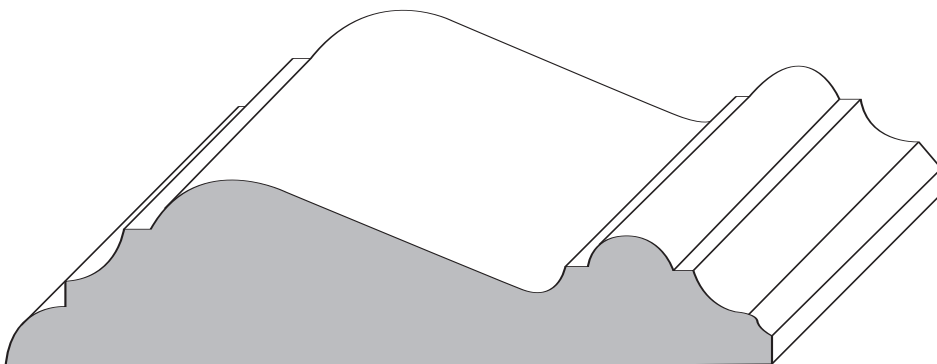

C-DS401
1 x 4

**To Place an Order - Call:
1-608-698-6645**

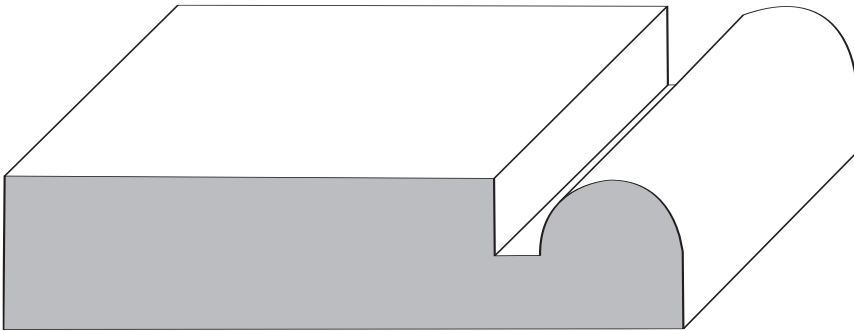

C-SM231
 $\frac{3}{4} \times 3\frac{1}{2}$

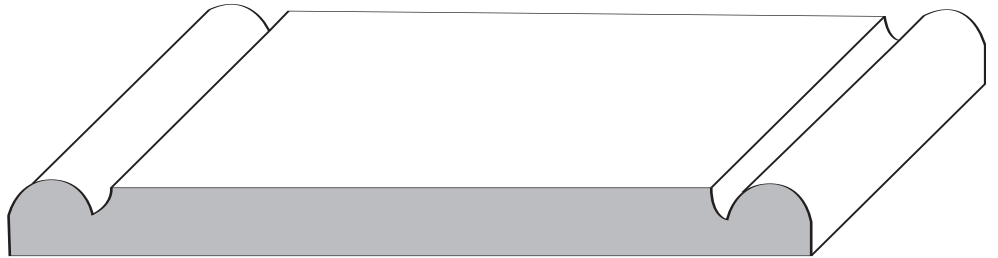

C-LO425
 $\frac{3}{8} \times 4\frac{1}{8}$

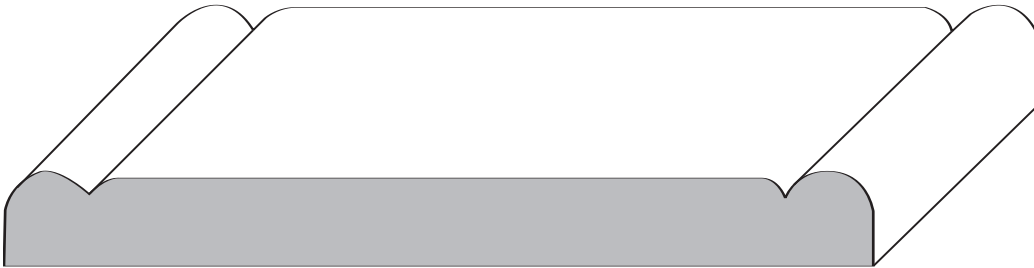

C-BO135
 $\frac{1}{2} \times 4\frac{1}{2}$

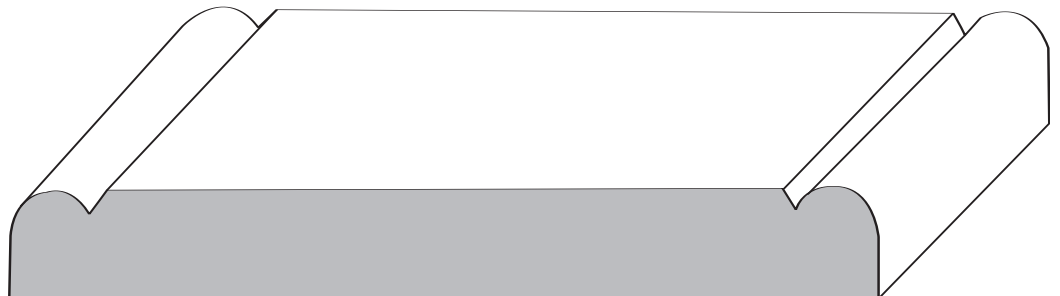

C-SM304
 $\frac{5}{8} \times 4\frac{1}{2}$

**To Place an Order - Call:
1-608-698-6645**



C-SE13
 $\frac{3}{4} \times 5\frac{1}{2}$



C-AH398
 $\frac{1}{2} \times 5\frac{1}{4}$

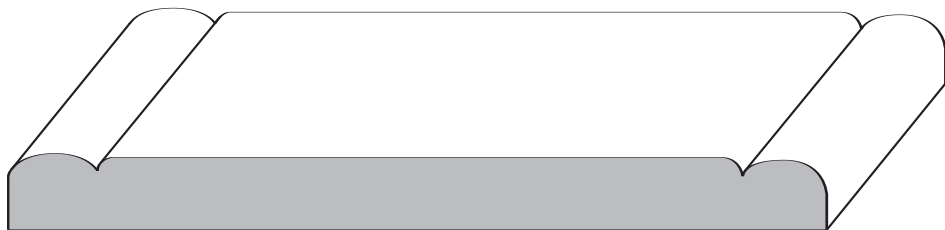

T-WM956
 $\frac{3}{8} \times 4\frac{1}{4}$